



Catalogue 2024

SECOLO_2024_ © All Rights Reserved

All contents, including but not limited to text, images, designs, graphics, photographs, and logos displayed within this catalogue are the intellectual property of Secolo. These contents are protected under applicable copyright laws. Any reproduction, modification, distribution, or republication of the catalogue or its contents in any form without the explicit written permission of Secolo is strictly prohibited. By accessing or using this catalogue, you acknowledge that you have read, understood, and agreed to the above copyright protection notice and disclaimer. If you do not agree with any part of this notice, you must refrain from using this catalogue. If you have any inquiries or require further information regarding the copyright or usage of our catalogue, please contact us through the provided communication channels.

Made In Italy With Love.



About

Established in 2018, Secolo is an Italian and UK based furniture brand with a desire to create iconic pieces that meet traditional tastes but with contemporary and unorthodox twists.

Secolo aims to offer unique, unseen pieces of design, which despite being playful and original will organically complement any interior.

Focusing on quality materials, Italian manufacturing and distinctive designs: SECOLO is producing furniture and accessories, which being made to order, means they are highly customisable, from the materials to the finishes and in some cases even dimensions.

We operate from bases in both London and Milan. Every Secolo product is 100% Made in Italy.



Index

Sofas & Armchairs

006.

- | | | | | | |
|------|---------------------|------|----------------------|------|-----------------------|
| 007. | Tateyama Sofa | 039. | Sibylia Sofa | 071. | Yoshida Family |
| 011. | Tateyama XL Sofa | 043. | Asawa Lounge Chair | 075. | Clip Lounge Chair |
| 015. | B15Z Lounge Chair | 047. | Asawa Sofa | 079. | Horizon Sofa |
| 019. | Tateyama Cloud Sofa | 051. | Yemeni Lounge Chair | 083. | Pop Lounge Chair |
| 023. | Tadao Sofa | 055. | Yemeni Sofa | 087. | Richmond Lounge Chair |
| 027. | Tadao Armchair | 059. | Yemeni Family | 091. | Chapter Two Sofa |
| 031. | Futura Sofa | 063. | Yoshida Lounge Chair | 095. | Archi Sofa |
| 035. | Sibylia Armchair | 067. | Yoshida Sofa | | |

Coffee & Side Tables

099.

- | | | | | | |
|------|------------------------|------|-------------------------------|------|---------------------|
| 100. | Pingu Side Table | 132. | Gemini Round Coffee Tables | 164. | Pangea Coffee Table |
| 104. | Pingu X Side Table | 136. | Gemini Soft Hex Coffee Tables | 168. | Taras Coffee Table |
| 108. | Laghi Monochrome | 140. | Book 1 & 2 Coffee Tables | 172. | Atlante Side Table |
| 112. | Laghi Coffee Tables | 144. | Tayma Coffee Table | 176. | Origin Side Table |
| 116. | Hiri Coffee Table | 148. | Tayma X Coffee Table | 180. | Sketch Side Table |
| 120. | Hiri Side Table | 152. | Arris Coffee Table | 184. | Orion Side Table |
| 124. | Kawa Coffee Tables | 156. | Arris Side Table | | |
| 128. | Fragment Coffee Tables | 160. | Lock Side Table | | |

Seating

188.

- | | | | | | |
|------|------------------------------|------|--------------|------|------------|
| 189. | Taoto Dining Chair | 209. | Nuba Pouf | 229. | Inge Chair |
| 193. | Giardino Botanico Collection | 213. | Nuba Bench | 233. | Inge Pouf |
| 197. | Masa Dining Chair | 217. | Nara Stool | 237. | Luna Chair |
| 201. | Richmond Dining Chair | 221. | Douglas Pouf | | |
| 205. | Richmond Barstool | 225. | Ollie Pouf | | |

Dining Tables

241.

- | | | | | | |
|------|-----------------------|------|--------------------------|------|---------------------------|
| 242. | Laghi I Dining Table | 254. | Inge Marble Dining Table | 266. | Horus Dining Table |
| 246. | Laghi II Dining Table | 258. | Silo Dining Table | 270. | Horus Marble Dining Table |
| 250. | Inge Dining Table | 262. | Monith Dining Table | | |

Desks & Consoles

274.

- | | | | | | |
|------|--------------|------|---------------|------|----------------|
| 275. | Lock Console | 283. | Roll Desk | 291. | Apollo Console |
| 279. | Kara Console | 287. | Nakamura Desk | 295. | Apollo Desk |

Mirrors

299.

- | | | | | | |
|------|---------------|------|---------------|------|---------------|
| 300. | Giove Mirror | 308. | Laghi Mirrors | 316. | Takada Mirror |
| 304. | Aglaia Mirror | 312. | 1931 Mirror | | |

Materials

320.

Contacts

331.

**007.Tateyama Sofa / 011.Tateyama XL Sofa / 015.B15Z Lounge Chair /
019.Tateyama Cloud Sofa / 023.Tadao Sofa / 027.Tadao Armchair / 031.Futura Sofa /
035.Sibylia Armchair / 039.Sibylia Sofa / 043.Asawa Lounge chair / 047.Asawa Sofa /
051.Yemeni Lounge Chair / 055.Yemeni Sofa / 059.Yemeni Family /
063.Yoshida Lounge Chair / 067.Yoshida Sofa / 071.Yoshida Family /
075.Clip Lounge Chair / 079.Horizon Sofa / 083.Pop Lounge Chair /
087.Richmond Lounge Chair / 091.Chapter Two Sofa / 095.Archi Sofa**

Sofas & Armchairs



We believe that storytelling through design has the power to shape and change our world. We believe in a more creative future.

Tateyama Sofa

Tateyama Sofa

Tateyama is a conversational sofa characterised by its soft curves and unusual shape which encourages the users to engage with one another. It is both welcoming and comfortable. A gap has been carved out of the backrest, opening the sofa up to the rest of the room.

Year 2019



The sofa can be upholstered in a number of different materials including COM. The belt and built-in side tables are available in metal or wood and in any of our metal finishes or wood stains respectively.

Finishes

Metal

Satin Aluminium
Satin Brass
Satin Bronze
Satin Champagne

Polished Aluminium
Polished Brass
Polished Bronze
Polished Champagne

Blue Cenere
Cenere
Jet Black
Off White

Wood

Dark Stained Walnut
Grey Stained Walnut
Natural Walnut
White Oak

Upholstery Standard Collection

Cocò
Cotton
Velvet

Upholstery Premium Collection

Nativo
Panama
Bouclé Mélange
Soft Bouclé

Upholstery Special Collection

Leather
Nabuk
Bouclé

Dimensions

250 W x 150 D x 42 seat H. Back H 72
275 W x 150 D x 42 seat H. Back H 72
300 W x 150 D x 42 seat H. Back H 72



Upholstery. Pearl Bush Bouclé

Metal. Satin Brass

01



Upholstery. Pearl Bush Bouclé

Metal. Satin Brass

02



03



04



05

Tateyama Sofa

Year 2019

W. Width D. Depth S.H. Seat Height B.H. Backrest Height

Dimensions

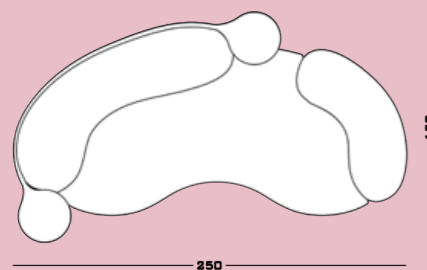

Cod. TATE250

W. 250
D. 150
S.H. 42
B.H. 72

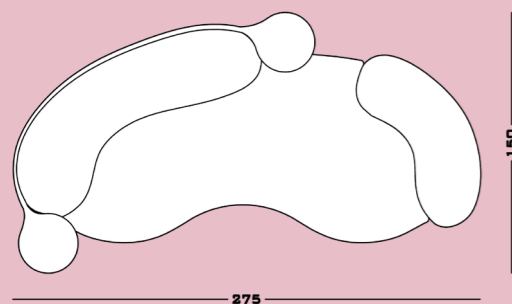

Cod. TATE275

W. 275
D. 150
S.H. 42
B.H. 72

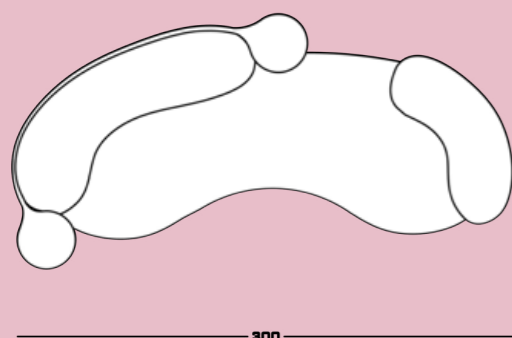

Cod. TATE300

W. 300
D. 150
S.H. 42
B.H. 72



We believe that storytelling through design has the power to shape and change our world. We believe in a more creative future.

Tateyama XL Sofa

Tateyama XL Sofa

Year 2021



Tateyama XL is a continuation of our Tateyama sofa, offering even more seating comfort in this XL model. Spanning 3 meters wide, the Tateyama XL has space for every member of the family. Low, individual backs make

it unobtrusive while remaining a focal point of a room. Tateyama XL is available in six configurations allowing for the perfect configuration for your space. The sofa can be upholstered in a number of different materials including COM.

Finishes

Metallic Effect

Satin Aluminium
Satin Brass
Satin Bronze
Satin Champagne

Polished Aluminium
Polished Brass
Polished Bronze
Polished Champagne

Blue Cenere
Cenere
Jet Black
Off White

Upholstery Standard Collection

Cocò
Cotton
Velvet

Upholstery Premium Collection

Nativo
Panama
Bouclé Mélange
Soft Bouclé

Upholstery Special Collection

Leather
Nabuk
Bouclé

Dimensions

- 275 W x 138 D x 42 seat H. Back H 72
- 285 W x 120 D x 42 seat H. Back H 72
- 285 W x 138 D x 42 seat H. Back H 72
- 300 W x 138 D x 42 seat H. Back H 72



Upholstery. Pearl Bush Bouclé

Metallic Effect. Satin Brass

01



Upholstery. Pearl Bush Bouclé

Metallic Effect. Satin Brass

02

03



04



05



Tateyama XL Sofa

Year 2021

W. Width D. Depth S.H. Seat Height B.H. Backrest Height

Dimensions

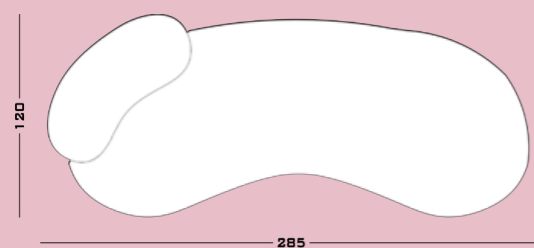

Cod. TATEXL1BL

W. 285
D. 120
S.H. 42
B.H. 72

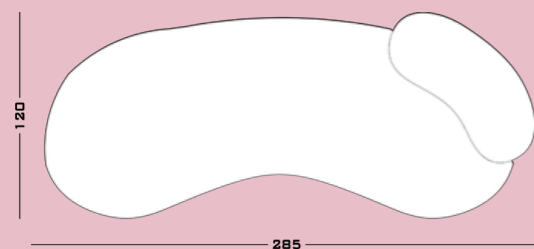

Cod. TATEXL1BR

W. 285
D. 120
S.H. 42
B.H. 72

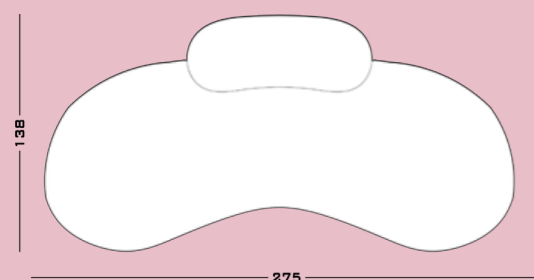

Cod. TATEXL1BC

W. 275
D. 138
S.H. 42
B.H. 72

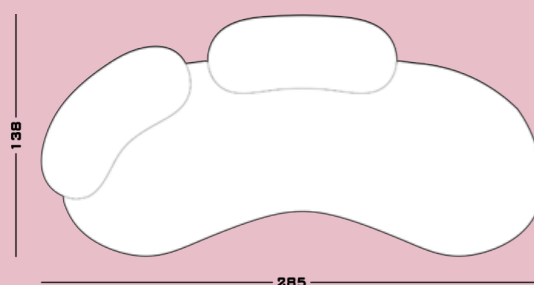

Cod. TATEXL2BL

W. 285
D. 138
S.H. 42
B.H. 72

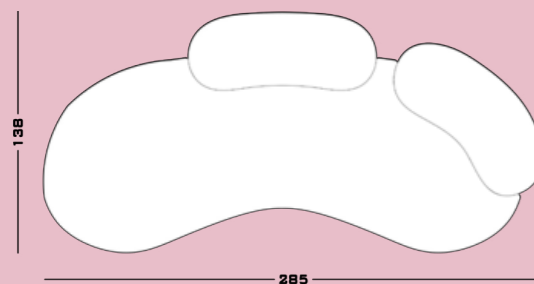

Cod. TATEXL2BR

W. 285
D. 138
S.H. 42
B.H. 72

Dimensions

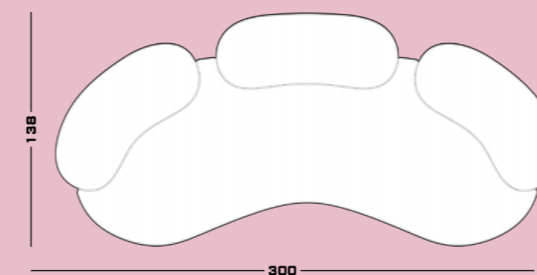

Cod. TATEXL3B

L. 300
D. 138
S.H. 42
B.H. 72

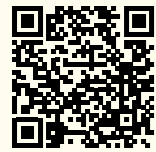

We believe that storytelling through design has the power to shape and change our world. We believe in a more creative future.

B15Z Lounge Chair

B15Z Lounge Chair

B15Z is named after a huge iceberg that broke away from an even larger ice shelf in Antarctica. B15Z looks like it was a piece of Tateyama but works as a perfect accompaniment or on its own.

Year 2019



It is slightly over-sized and extremely comfortable. Available in two standard sizes, B15Z is a soft lounge chair perfect for any situation or setting.

Finishes

Metallic Effect

Satin Aluminium
Satin Brass
Satin Bronze
Satin Champagne

Polished Aluminium
Polished Brass
Polished Bronze
Polished Champagne

Blue Cenere
Cenere
Jet Black
Off White

Upholstery Standard Collection

Cocò
Cotton
Velvet

Upholstery Premium Collection

Nativo
Panama
Bouclé Mélange
Soft Bouclé

Upholstery Special Collection

Leather
Nabuk
Bouclé

Dimensions

80 W x 78 D x 42 seat H. Back H 72
100 W x 98 D x 42 seat H. Back H 72



Upholstery. Pearl Bush Bouclé

Metallic Effect. Satin Brass

01



Upholstery. Pearl Bush Bouclé

Metallic Effect. Satin Brass

02



03

04



05

B15Z Lounge Chair

Year 2019

W. Width D. Depth S.H. Seat Height B.H. Backrest Height

Dimensions

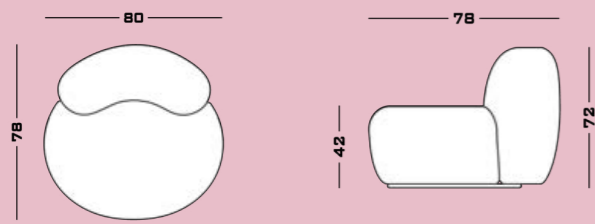

Cod. BZ80

W.	80
D.	78
S.H.	42
B.H.	72

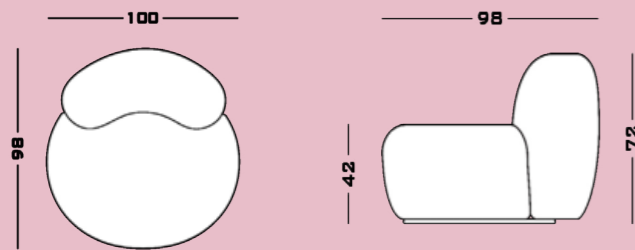

Cod. BZ100

W.	100
D.	98
S.H.	42
B.H.	72



We believe that storytelling through design has the power to shape and change our world. We believe in a more creative future.

Tateyama Cloud Sofa

Tateyama Cloud Sofa

Tateyama is a conversational sofa characterised by its soft curves and unusual shape which encourages the users to engage with one another. It is both welcoming and comfortable. A gap has been carved out of the backrest, opening the sofa up to the rest of the room.

Year 2022



The sofa can be upholstered in a number of different materials including COM.

Finishes

Metallic Effect

Satin Aluminium
Satin Brass
Satin Bronze
Satin Champagne

Polished Aluminium
Polished Brass
Polished Bronze
Polished Champagne

Blue Cenere
Cenere
Jet Black
Off White

Upholstery Standard Collection

Cocò
Cotton
Velvet

Upholstery Premium Collection

Nativo
Panama
Bouclé Mélange
Soft Bouclé

Upholstery Special Collection

Leather
Nabuk
Bouclé

Dimensions

250 W x 125 D x 42 seat H. Back H 72
275 W x 125 D x 42 seat H. Back H 72
300 W x 125 D x 42 seat H. Back H 72



Upholstery. Pearl Bush Bouclé

Metallic Effect. Satin Brass

01



Upholstery. Bison Hide Bouclé

Metallic Effect. Satin Brass

02

03



04



05



Tateyama Cloud Sofa

Year 2022

W. Width D. Depth S.H. Seat Height B.H. Backrest Height

Dimensions

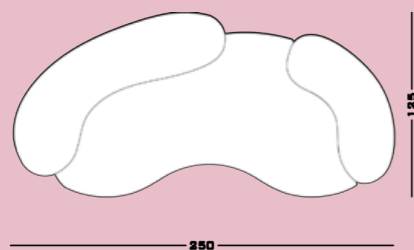

Cod. TATE250NB

W.	250
D.	125
S.H.	42
B.H.	72

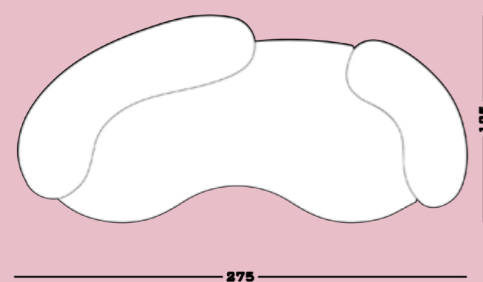

Cod. TATE275NB

W.	275
D.	125
S.H.	42
B.H.	72

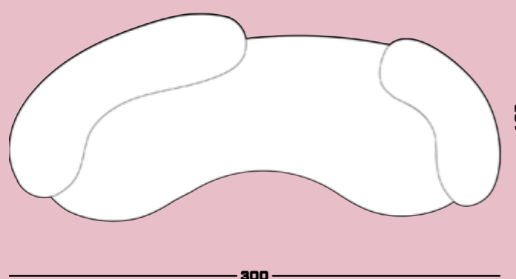

Cod. TATE300NB

W.	300
D.	125
S.H.	42
B.H.	72



We believe that storytelling through design has the power to shape and change our world. We believe in a more creative future.

Tadao Sofa

Tadao Sofa

Plainly taking influence from Brutalist architecture and those who pioneered it, the Tadao sofa comprises of two contrasting parts. The first is a square, heavy, minimal, brutalist structure that wraps and holds in place four soft and inviting cushions.

Brutalism doesn't try to hide but instead is proud of every element, by the same token, TADAO's exposed structure adds functionality, the unique proportions offering ample space to rest an arm, a glass or a book.

Year 2024



Finishes

Wood

Dark Stained Walnut
Grey Stained Walnut
Natural Walnut
White Oak

Upholstery Standard Collection

Cocò
Cotton
Velvet

Upholstery Premium Collection

Nativo
Panama
Bouclé Mélange
Soft Bouclé

Upholstery Special Collection

Leather
Nabuk
Bouclé

Dimensions

284 W x 117 D x 77 H seat H. 42



Upholstery. Alto White Nativo

Wood. Natural Walnut

01



Upholstery. Alto White Nativo

Wood. Natural Walnut

02

03



04



Tadao Sofa

Year 2024

W. Width D. Depth S.H. Seat Height B.H. Backrest Height

Dimensions

Cod. TAD2S

W. 284
D. 117
S.H. 42
B.H. 77

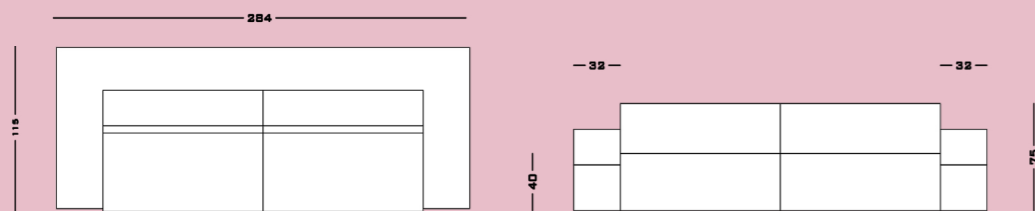



We believe that storytelling through design has the power to shape and change our world. We believe in a more creative future.

Tadao Armchair

Tadao Armchair

Plainly taking influence from Brutalist architecture and those who pioneered it, the Tadao armchair comprises of two contrasting parts. The first is a square, heavy, minimal, brutalist structure that wraps and holds in place four soft and inviting cushions.

Brutalism doesn't try to hide but instead is proud of every element, by the same token, TADAO's exposed structure adds functionality, the unique proportions offering ample space to rest an arm, a glass or a book.

Year 2024



Finishes

Wood

Dark Stained Walnut
Grey Stained Walnut
Natural Walnut
White Oak

Upholstery Standard Collection

Cocò
Cotton
Velvet

Upholstery Premium Collection

Nativo
Panama
Bouclé Mélange
Soft Bouclé

Upholstery Special Collection

Leather
Nabuk
Bouclé

Dimensions

174 W x 117 D x 77 H seat H. 42



Upholstery. Alto White Nativo

Wood. Natural Walnut

01



Upholstery. Alto White Nativo

Wood. Natural Walnut

02



Tadao Armchair

Year 2024

W. Width D. Depth S.H. Seat Height B.H. Backrest Height

Dimensions

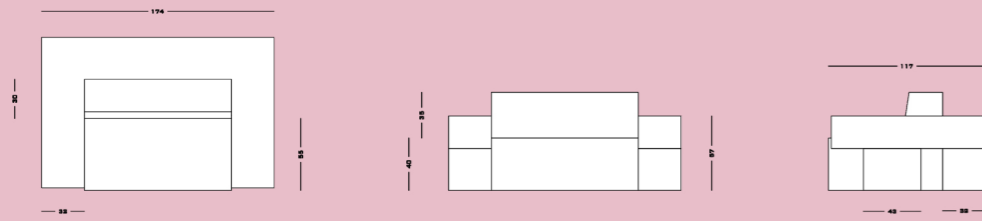

Cod. TAD1S

W. 174
D. 117
S.H. 42
B.H. 77



We believe that storytelling through design has the power to shape and change our world. We believe in a more creative future.

Futura Sofa

Futura Sofa

Year 2024



FUTURA is a series of units designed to be assembled into unique, unexpected forms. The pieces are unified by an expansive back that continues from end to end connecting one piece to the next across a series of surprising angles.

The inside and outside of the sofa are contrasted in both forms and detailing, the result of which is a comfortable, enveloping sofa with a unique and contemporary twist.

Finishes

Upholstery Standard Collection

Cocò
Cotton
Velvet

Upholstery Premium Collection

Nativo
Panama
Bouclé Mélange
Soft Bouclé

Upholstery Special Collection

Leather
Nabuk
Bouclé

Dimensions

- 80 W x 120 D x 80 H seat H. 42
- 80 W x 80 D seat H. 42
- 156 W x 177 D x 80 H seat H. 42
- 120 W x 120 D x 80 H seat H. 42
- 200 W x 120 D x 80 H seat H. 42
- 377 W x 156,5 D x 80 H seat H. 42
- 353,4 W x 156,5 D x 80 H seat H. 42
- 476,6 W x 214,5 D x 80 H seat H. 42
- 400 W x 120 D x 80 H seat H. 42
- 557,5 W x 212,5 D x 80 H seat H. 42
- 442 W x 305 D x 80 H seat H. 42
- 651,5 W x 284 D x 80 H seat H. 42



Upholstery. Mercury White Cotton

01



Upholstery. Mercury White Cotton

02

03



04



Futura Sofa

Year 2024

W. Width D. Depth S.H. Seat Height B.H. Backrest Height

Dimensions

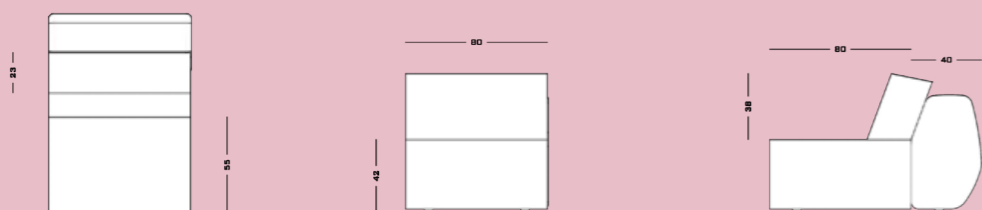

Cod. FUTS

W. 80
D. 120
S.H. 42
B.H. 77



Cod. FUTP

W. 80
D. 80
S.H. 42

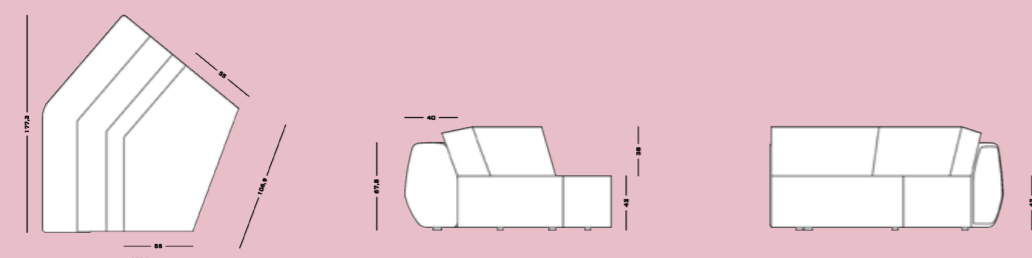

Cod. FUTN

W. 156
D. 177
S.H. 42
B.H. 77

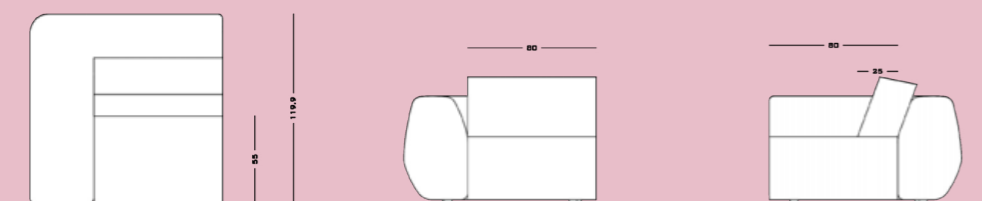

Cod. FUTC

W. 120
D. 120
S.H. 42
B.H. 77

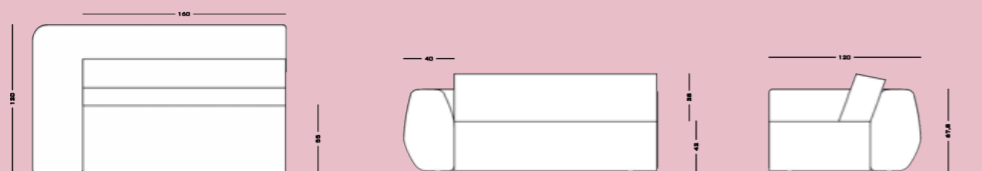

Cod. FUTCL

W. 200
D. 120
S.H. 42
B.H. 77



Cod. FUTCR

W. 200
D. 120
S.H. 42
B.H. 77

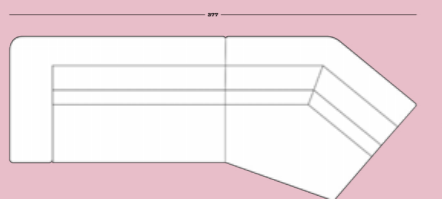

Cod. FUTCLN

W. 377
D. 156,5
S.H. 42
B.H. 77

Dimensions

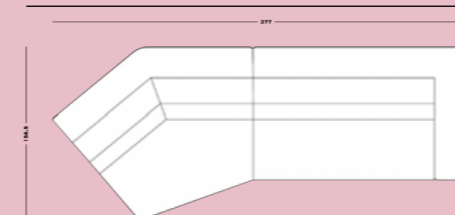

Cod. FUTCRN

W. 377
D. 156,5
S.H. 42
B.H. 77

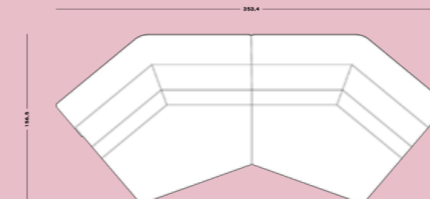

Cod. FUT2N

W. 353,4
D. 156,5
S.H. 42
B.H. 77

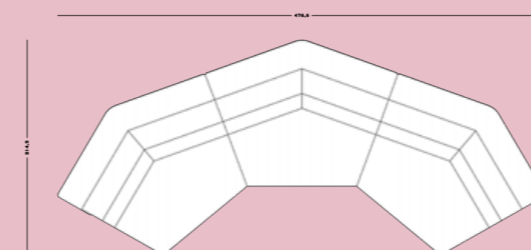

Cod. FUT3N

W. 476,6
D. 214,5
S.H. 42
B.H. 77

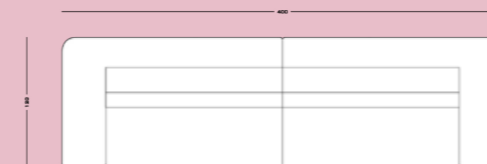

Cod. FUTCLR

W. 400
D. 120
S.H. 42
B.H. 77

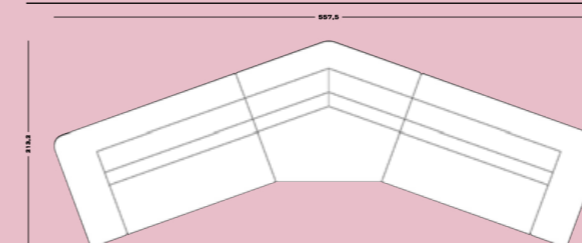

Cod. FUTCLRN

W. 557,5
D. 212,5
S.H. 42
B.H. 77

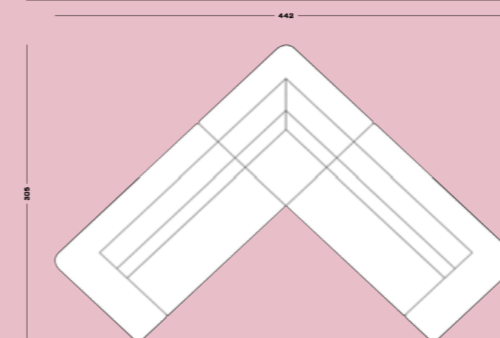

Cod. FUTCLRC

W. 442
D. 305
S.H. 42
B.H. 77

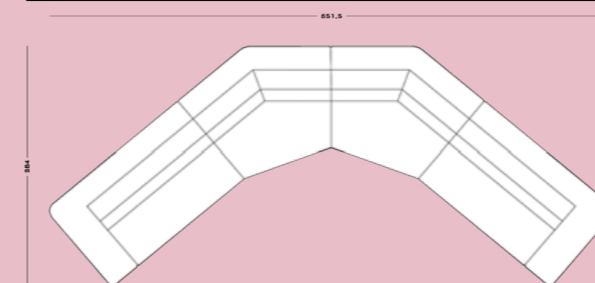

Cod. FUTCLR2N

W. 651,5
D. 284
S.H. 42
B.H. 77



We believe that storytelling through design has the power to shape and change our world. We believe in a more creative future.

Sibyllia Armchair

Sibylia Armchair

Sibylia is a modular sofa characterised by its exaggerated and over-relaxed appearance. Oversized stitches define the edges each individual piece of the sofa.

Year 2023



Offering maximum sink-in comfort, Sibylia is available in different sizes and many leather options.

Finishes

Upholstery Standard Collection

Cocò
Cotton
Velvet

Upholstery Premium Collection

Nativo
Panama
Bouclé Mélange
Soft Bouclé

Upholstery Special Collection

Leather
Nabuk
Bouclé

Dimensions

134 W x 100 D x 42 seat H. Back H 85



Upholstery. Clay Leather

01



Upholstery. Clay Leather

02

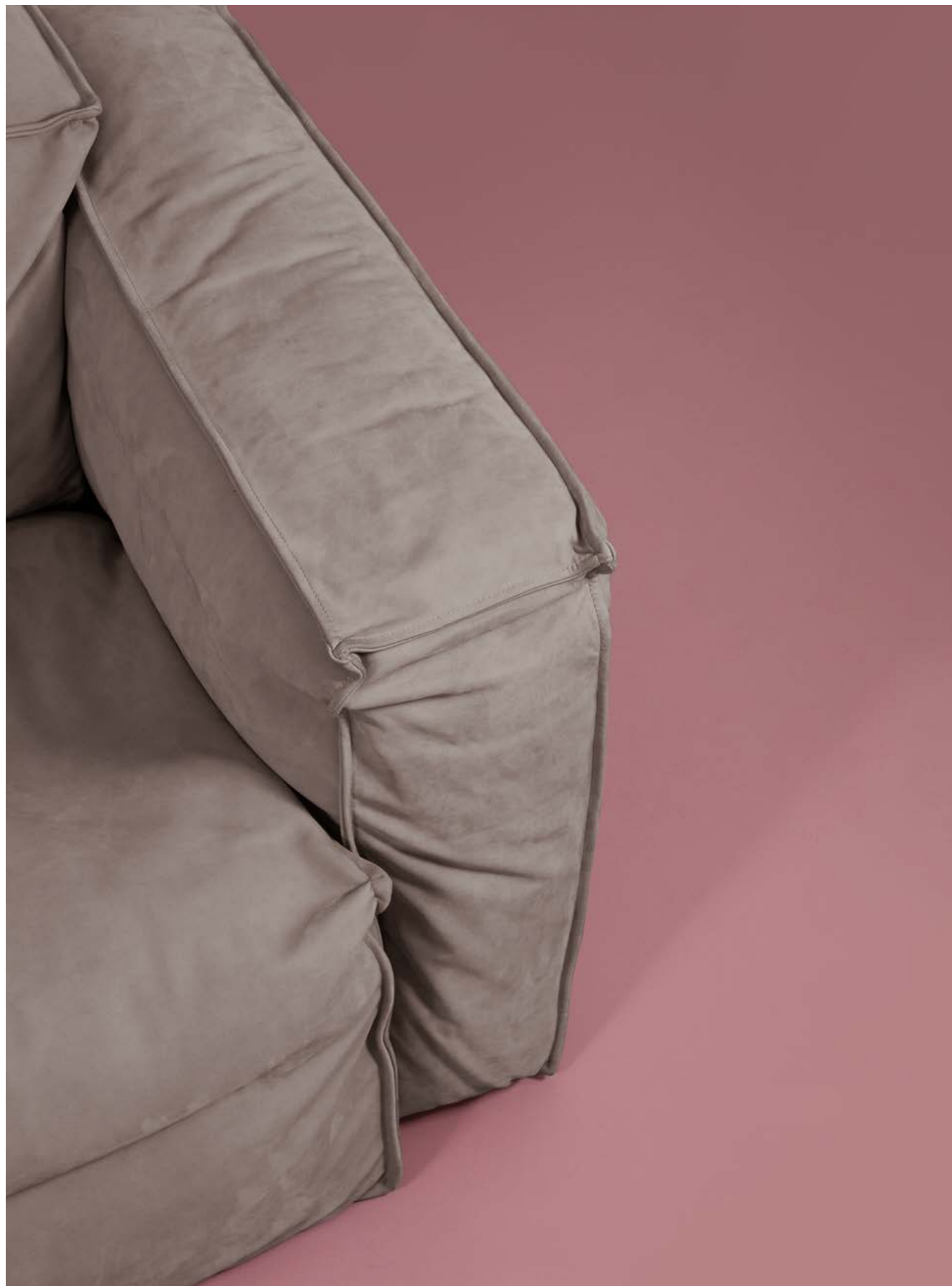

03



04



05

Sibylia Armchair

Year 2023

W. Width D. Depth S.H. Seat Height B.H. Backrest Height

Dimensions

Cod. SIB1S

W. 134
D. 100
S.H. 42
B.H. 85

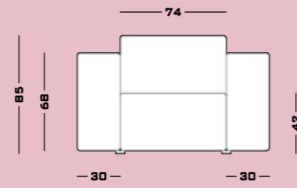
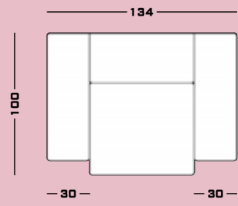



We believe that storytelling through design has the power to shape and change our world. We believe in a more creative future.

Sibyllia Sofa

Sibylia Sofa

Sibylia is a modular sofa characterised by its exaggerated and over-relaxed appearance. Oversized stitches define the edges each individual piece of the sofa.

Year 2023



Offering maximum sink-in comfort, Sibylia is available in different sizes and many leather options.

Finishes

Upholstery Standard Collection

Cocò
Cotton
Velvet

Upholstery Premium Collection

Nativo
Panama
Bouclé Mélange
Soft Bouclé

Upholstery Special Collection

Leather
Nabuk
Bouclé

Dimensions

208 W x 100 D x 42 seat H. Back H 85
282 W x 100 D x 42 seat H. Back H 85
356 W x 100 D x 42 seat H. Back H 85



Upholstery. Grayshadow Leather

01



Upholstery. Grayshadow Leather

02

03



04



Sibylia Sofa

Year 2023

W. Width D. Depth S.H. Seat Height B.H. Backrest Height

Dimensions

Cod. SIB2S

W. 208
D. 100
S.H. 42
B.H. 85

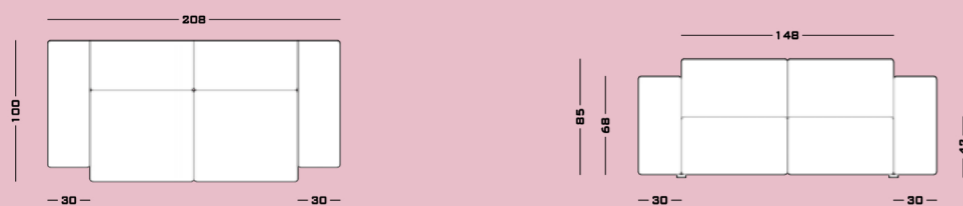

Cod. SIB3S

W. 282
D. 100
S.H. 42
B.H. 85

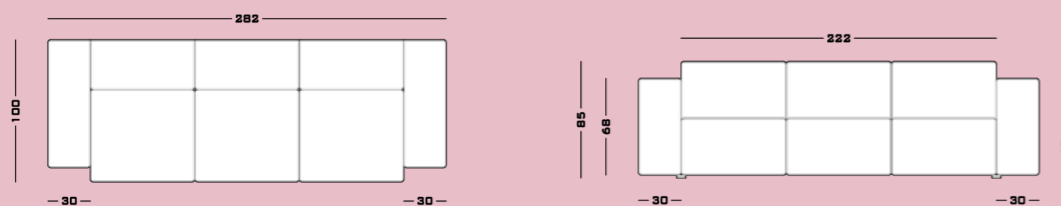

Cod. SIB4S

W. 356
D. 100
S.H. 42
B.H. 85

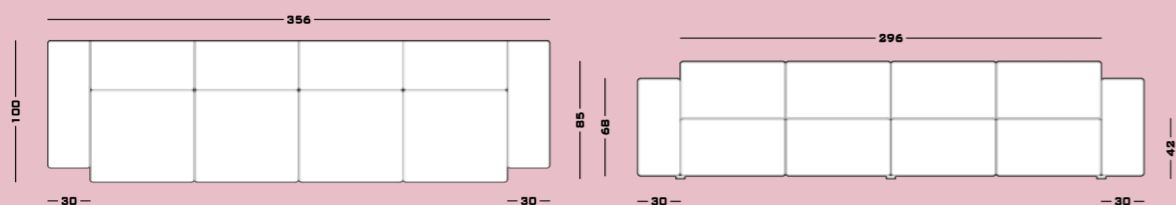



We believe that storytelling through design has the power to shape and change our world. We believe in a more creative future.

Asawa Lounge Chair

Asawa Lounge Chair

The Asawa Lounge Chair, accompaniment to the Asawa sofa, is characterised by a sculptural and organic back which seems to have grown from the ground up.

Year 2023



A solid wood piece acts as the base for this curving and enveloping structure. Asawa is customisable in many fabric, leather and wood options.

Finishes

Wood

Dark Stained Walnut
Grey Stained Walnut
Natural Walnut
White Oak

Upholstery Standard Collection

Cocò
Cotton
Velvet

Upholstery Premium Collection

Nativo
Panama
Bouclé Mélange
Soft Bouclé

Upholstery Special Collection

Leather
Nabuk
Bouclé

Dimensions

80 W x 90 D x 42 seat H. Back H 77



Upholstery. Pearl Bush Bouclé

Wood. White Oak

01



Upholstery. Pearl Bush Bouclé

Wood. White Oak

02



03

04



05



Asawa Lounge Chair

Year 2023

W. Width D. Depth S.H. Seat Height B.H. Backrest Height

Dimensions

Cod. ASAWA1S

W. 80
D. 90
S.H. 42
B.H. 77

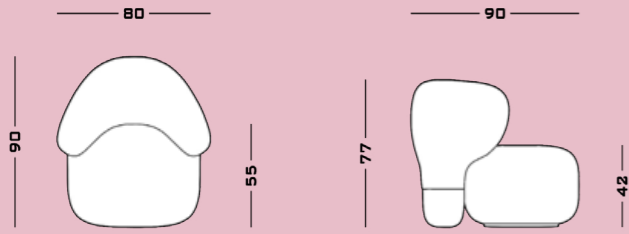



We believe that storytelling through design has the power to shape and change our world. We believe in a more creative future.

Asawa Sofa

Asawa Sofa

Year 2023



The Asawa sofa is characterised by a sculptural and organic back which seems to have grown from the ground up. Two solid wood pieces act as the base for this curving and enveloping structure which wraps around the base of the sofa. The curved seat of the sofa means Asawa takes

center-stage, always slightly away from the wall, opening itself up to the room from all angles. Asawa is available with 3 distinct sizes of seat as well as in an accompanying armchair version. Asawa is customisable in many fabric, leather and wood options.

Finishes

Wood

Dark Stained Walnut
Grey Stained Walnut
Natural Walnut
White Oak

Upholstery Standard Collection

Cocò
Cotton
Velvet

Upholstery Premium Collection

Nativo
Panama
Bouclé Mélange
Soft Bouclé

Upholstery Special Collection

Leather
Nabuk
Bouclé

Dimensions

200 W x 100 D x 42 seat H. Back H 80
240 W x 105 D x 42 seat H. Back H 80
280 W x 110 D x 42 seat H. Back H 80



Upholstery. Pearl Bush Bouclé

Wood. White Oak

01



Upholstery. Pearl Bush Bouclé

Wood. White Oak

02



03

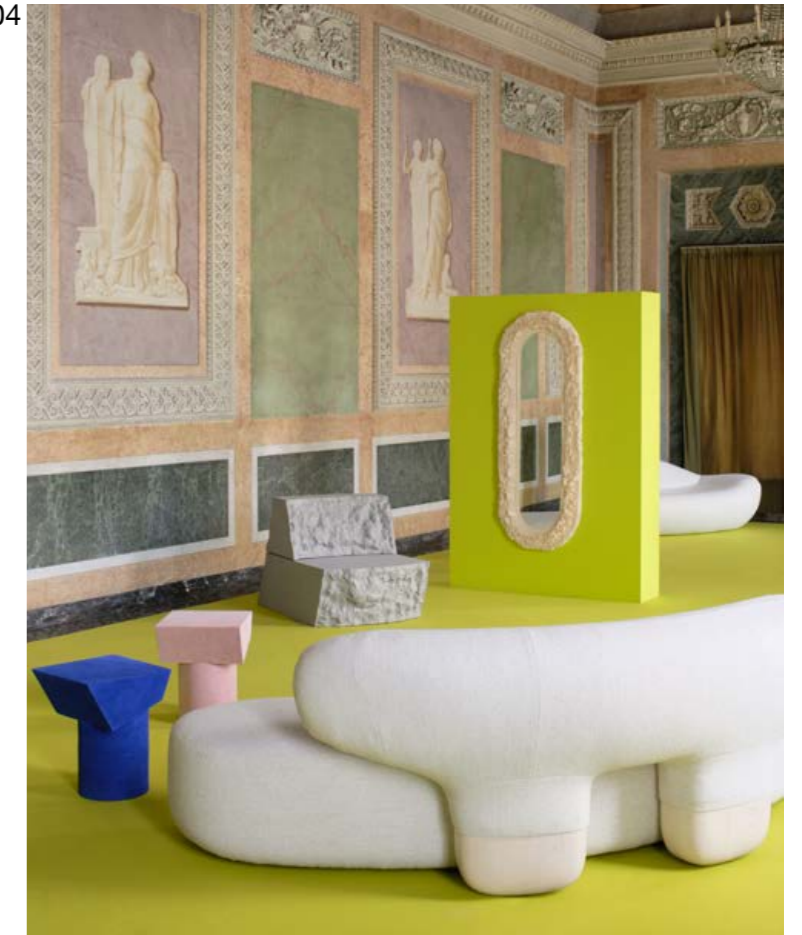

04



05

Asawa Sofa

Year 2023

W. Width D. Depth S.H. Seat Height B.H. Backrest Height

Dimensions

Cod. ASAWA200

W.	200
D.	100
S.H.	42
B.H.	80

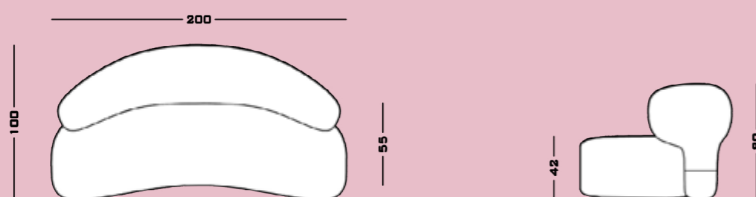

Cod. ASAWA240

W.	240
D.	105
S.H.	42
B.H.	80

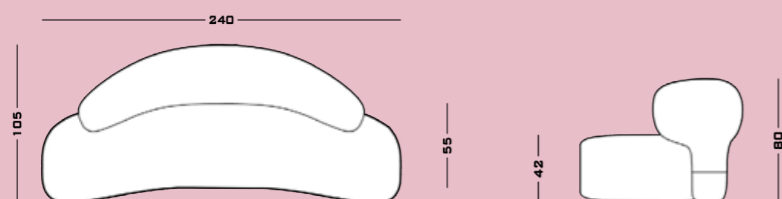

Cod. ASAWA280

W.	280
D.	110
S.H.	42
B.H.	80

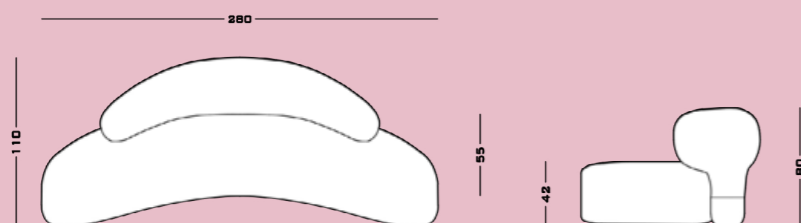



We believe that storytelling through design has the power to shape and change our world. We believe in a more creative future.

Yemeni Lounge Chair

Yemeni Lounge Chair

Year 2021



The Yemeni Series takes its name from the incredible ruins and remains of monuments left in the Yemeni Deserts.

Parallel slabs of solid wood support an upholstered back, giving a surprising yet functional detail. Available in large single seater, corner and sofa versions.

Finishes

Wood

Dark Stained Walnut
Grey Stained Walnut
Natural Walnut
White Oak

Upholstery Standard Collection

Cocò
Cotton
Velvet

Upholstery Premium Collection

Nativo
Panama
Bouclé Mélange
Soft Bouclé

Upholstery Special Collection

Leather
Nabuk
Bouclé

Dimensions

80 W x 92 D x 42 seat H. Back H 72



Upholstery. Pearl Bush Bouclé

Wood. White Oak

01



Upholstery. Pearl Bush Bouclé

Wood. White Oak

02



03



04



05

Yemeni Lounge Chair

Year 2021

W. Width D. Depth S.H. Seat Height B.H. Backrest Height

Dimensions

Cod. YMN1S

W. 80
D. 92
S.H. 42
B.H. 72

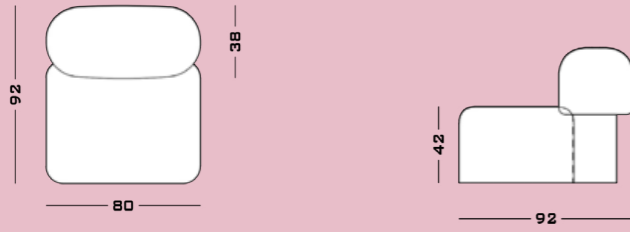



We believe that storytelling through design has the power to shape and change our world. We believe in a more creative future.

Yemeni Sofa

Yemeni Sofa

The Yemeni Series takes its name from the incredible ruins and remains of monuments left in the Yemeni Deserts.

Year 2021



Parallel slabs of solid wood support an upholstered back, giving a surprising yet functional detail. Available in large single seater, corner and sofa versions.

Finishes

Wood

Dark Stained Walnut
Grey Stained Walnut
Natural Walnut
White Oak

Upholstery Standard Collection

Cocò
Cotton
Velvet

Upholstery Premium Collection

Nativo
Panama
Bouclé Mélange
Soft Bouclé

Upholstery Special Collection

Leather
Nabuk
Bouclé

Dimensions

180 W x 92 D x 42 seat H. Back H 72



Upholstery. Pearl Bush Bouclé

Wood. White Oak

01



Upholstery. Pearl Bush Bouclé

Wood. White Oak

02



Yemeni Sofa

Year 2021

W. Width D. Depth S.H. Seat Height B.H. Backrest Height

Dimensions

Cod. YMN2S

W. 180

D. 92

S.H. 42

B.H. 72

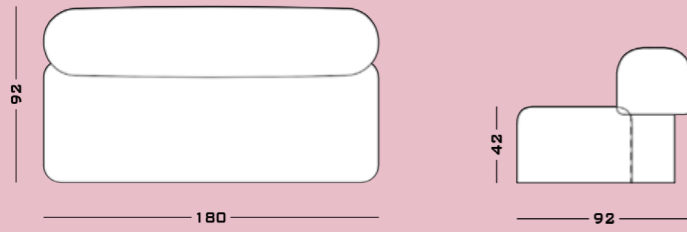



We believe that storytelling through design has the power to shape and change our world. We believe in a more creative future.

Yemeni Family

Yemeni Family

The Yemeni Series takes its name from the incredible ruins and remains of monuments left in the Yemeni Deserts.

Year 2021



Parallel slabs of solid wood support an upholstered back, giving a surprising yet functional detail. Available in large single seater, corner and sofa versions.

Finishes

Wood

Dark Stained Walnut
Grey Stained Walnut
Natural Walnut
White Oak

Upholstery Standard Collection

Cocò
Cotton
Velvet

Upholstery Premium Collection

Nativo
Panama
Bouclé Mélange
Soft Bouclé

Upholstery Special Collection

Leather
Nabuk
Bouclé

Dimensions

92 W x 92 D x 42 seat H. Back H 72
180 W x 92 D x 42 seat H. Back H 72
272 W x 172 D x 42 seat H. Back H 72
364 W x 172 D x 42 seat H. Back H 72
364 W x 272 D x 42 seat H. Back H 72



Upholstery. Sandstone Cotton

Wood. Dark Stained Walnut

01



Upholstery. Sandstone Cotton

Wood. Dark Stained Walnut

02

03



04



05



Yemeni Family

Year 2021

W. Width D. Depth S.H. Seat Height B.H. Backrest Height

Dimensions



Cod. YMN1S

W. 80
D. 92
S.H. 42
B.H. 72



Cod. YMN1SC

W. 92
D. 92
S.H. 42
B.H. 72

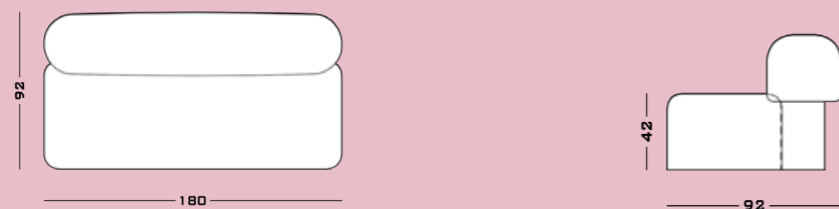

Cod. YMN2S

W. 180
D. 92
S.H. 42
B.H. 72

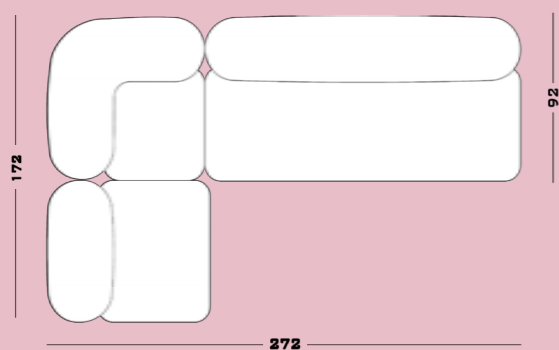

Cod. YMN1S1SC2S

W. 272
D. 172
S.H. 42
B.H. 72

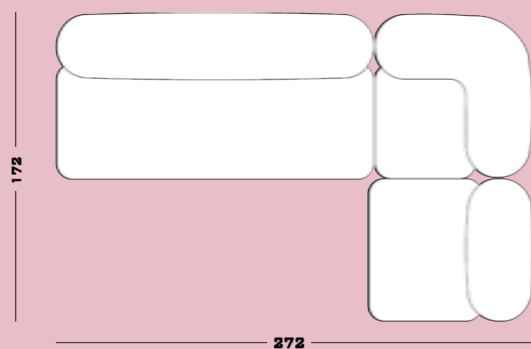

Cod. YMN2S1SC1S

W. 272
D. 172
S.H. 42
B.H. 72

Dimensions

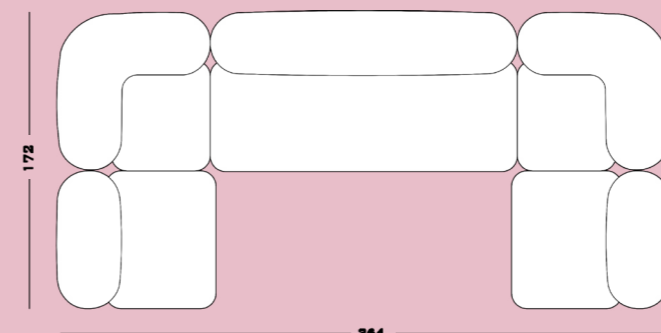

Cod. YMNU1S

W. 364
D. 172
S.H. 42
B.H. 72

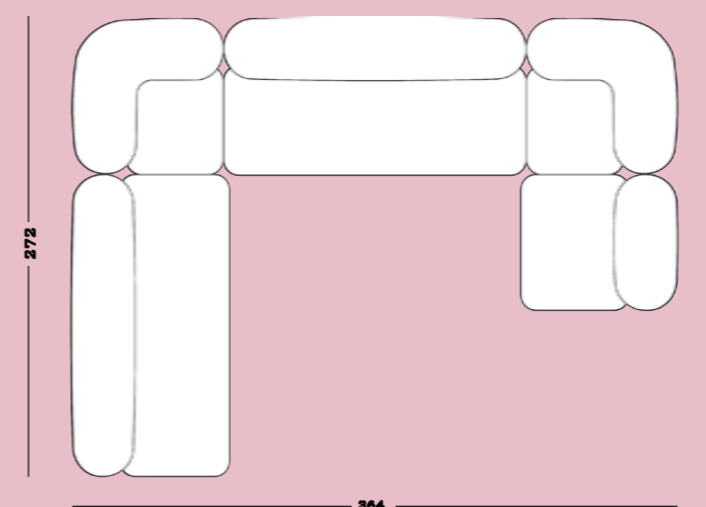

Cod. YMNU2S1S

W. 364
D. 272
S.H. 42
B.H. 72

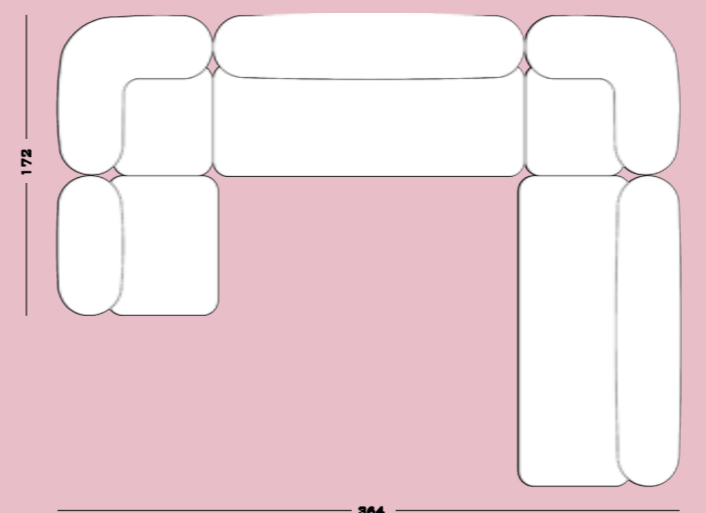

Cod. YMNU1S2S

W. 364
D. 272
S.H. 42
B.H. 72



We believe that storytelling through design has the power to shape and change our world. We believe in a more creative future.

Yoshida Lounge Chair

Yoshida Lounge Chair

Year 2021



The Yoshida Lounge chair is a minimal piece designed to look great from all angles. From the front, two oversized cushions seem to float, unsupported and balancing in place. From behind you see a large solid wood piece

which acts as both the base and the back of the chair, containing within it the large fully upholstered seat and back. Available in different wood finishes and upholstery options.

Finishes

Wood

Dark Stained Walnut
Grey Stained Walnut
Natural Walnut
White Oak

Upholstery Standard Collection

Cocò
Cotton
Velvet

Upholstery Premium Collection

Nativo
Panama
Bouclé Mélange
Soft Bouclé

Upholstery Special Collection

Leather
Nabuk
Bouclé

Dimensions

80 W x 80 D x 42 seat H. Back H 72



Upholstery. Bison Hide Bouclé

Wood. White Oak

01



Upholstery. Bison Hide Bouclé

Wood. White Oak

02

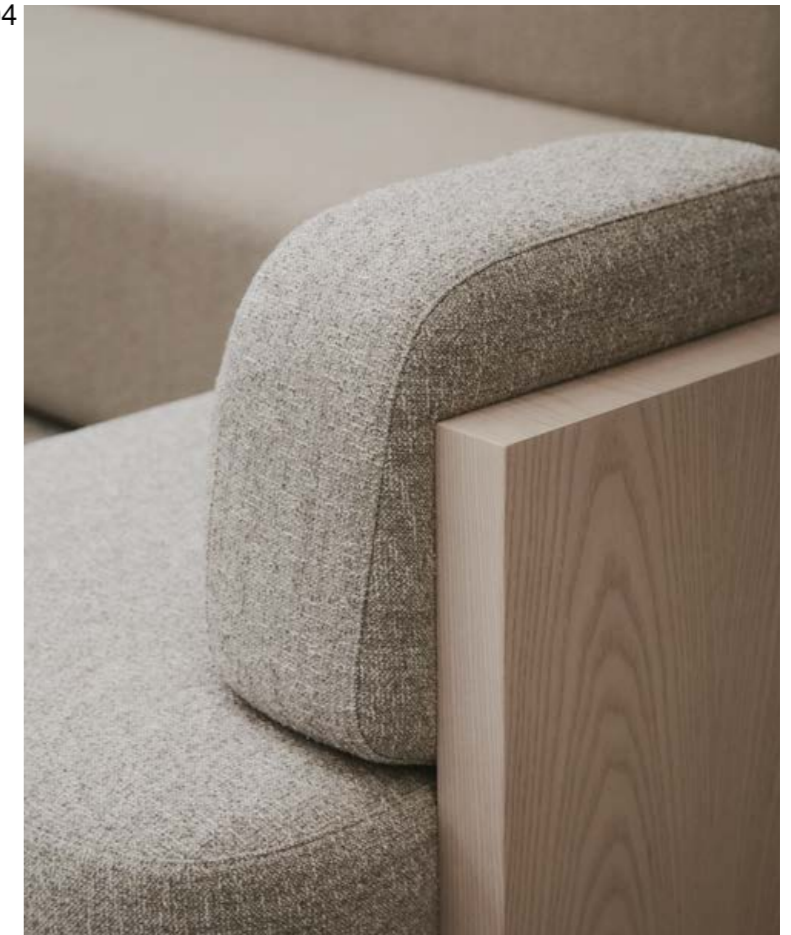

Yoshida Lounge Chair

Year 2021

W. Width D. Depth S.H. Seat Height B.H. Backrest Height

Dimensions

Cod. YSH1S

W. 80
D. 80
S.H. 42
B.H. 72





We believe that storytelling through design has the power to shape and change our world. We believe in a more creative future.

Yoshida Sofa

Yoshida Sofa

Year 2021



The Yoshida sofa is a minimal piece designed to look great from all angles. From the front, two oversized cushions seem to float, unsupported and balancing in place. From behind you see two large solid wood

pieces which act as both the base and the back of the sofa, containing within it the large fully upholstered seat and back. Available in different wood finishes and upholstery options.

Finishes

Wood

Dark Stained Walnut
Grey Stained Walnut
Natural Walnut
White Oak

Upholstery Standard Collection

Cocò
Cotton
Velvet

Upholstery Premium Collection

Nativo
Panama
Bouclé Mélange
Soft Bouclé

Upholstery Special Collection

Leather
Nabuk
Bouclé

Dimensions

160 W x 80 D x 42 seat H. Back H 72



Upholstery. Bison Hide Bouclé

Wood. White Oak

01



Upholstery. Bison Hide Bouclé

Wood. White Oak

02

03



04



Yoshida Sofa

Year 2021

W. Width D. Depth S.H. Seat Height B.H. Backrest Height

Dimensions

Cod. YSH2S

W. 160
D. 80
S.H. 42
B.H. 72





We believe that storytelling through design has the power to shape and change our world. We believe in a more creative future.

Yoshida Family

Yoshida Family

Year 2021



The Yoshida family is a minimal piece designed to look great from all angles. From the front, two oversized cushions seem to float, unsupported and balancing in place. From behind you see two large solid wood

pieces which act as both the base and the back of the sofa, containing within it the large fully upholstered seat and back. Available in different wood finishes and upholstery options.

Finishes

Wood

Dark Stained Walnut
Grey Stained Walnut
Natural Walnut
White Oak

Upholstery Standard Collection

Cocò
Cotton
Velvet

Upholstery Premium Collection

Nativo
Panama
Bouclé Mélange
Soft Bouclé

Upholstery Special Collection

Leather
Nabuk
Bouclé

Dimensions

70 W x 70 D x 42 H
240 W x 160 D x 42 seat H. Back H 72
320 W x 160 D x 42 seat H. Back H 72
320 W x 240 D x 42 seat H. Back H 72



Upholstery. Pearl Bush Bouclé

Wood. Dark Stained Walnut

01



Upholstery. Pale Oyster Bouclé

Wood. Dark Stained Walnut

02

03



04



05



Yoshida Family

Year 2021

W. Width D. Depth S.H. Seat Height B.H. Backrest Height

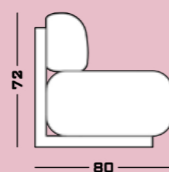
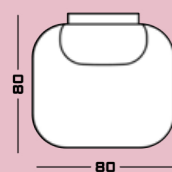

Cod. YSH1S

W. 80
D. 80
S.H. 42
B.H. 72

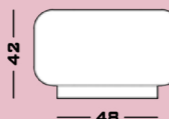
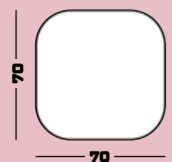

Cod. YSH1C

W. 70
D. 70
S.H. 42

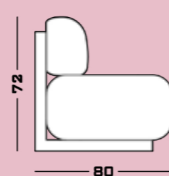
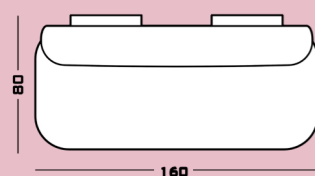

Cod. YSH2S

W. 160
D. 80
S.H. 42
B.H. 72

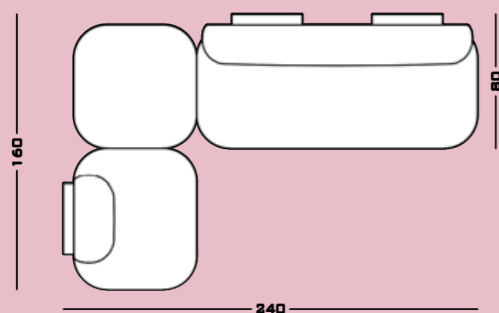

Cod. YSH1S1C2S

W. 240
D. 160
S.H. 42
B.H. 72

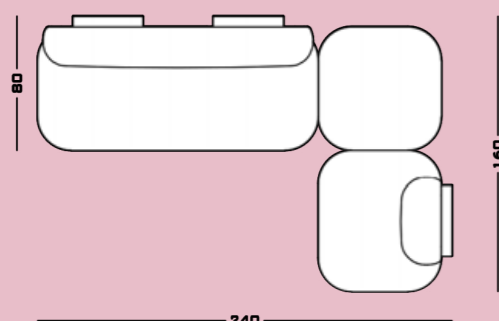

Cod. YSH2S1C1S

W. 240
D. 160
S.H. 42
B.H. 72

Dimensions

Cod. YSHU1S

W. 320
D. 160
S.H. 42
B.H. 72

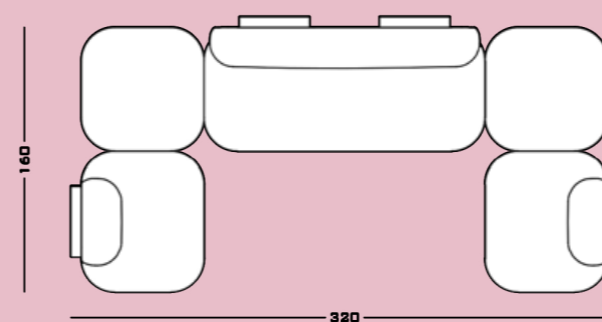

Cod. YSHU2S1S

W. 320
D. 240
S.H. 42
B.H. 72

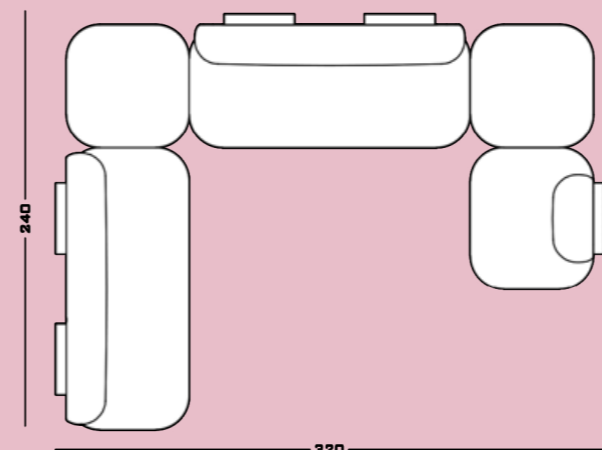

Cod. YSHU1S2S

W. 320
D. 240
S.H. 42
B.H. 72

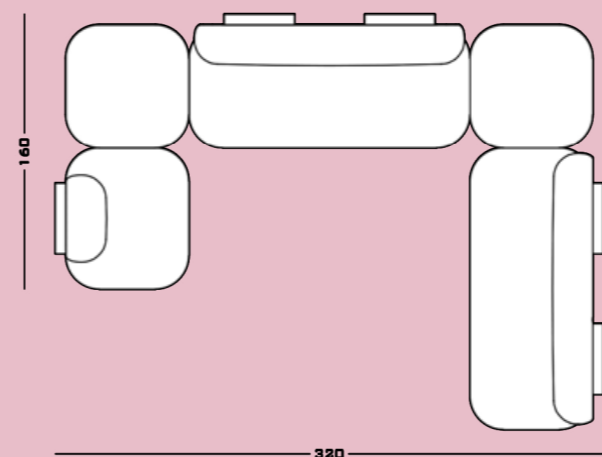



We believe that storytelling through design has the power to shape and change our world. We believe in a more creative future.

Clip Lounge Chair

Clip Lounge Chair

The Clip Lounge chair features two upholstered elements, a back and a base, connected by a single, visible piece of wood which sits flush with the two upholstered pieces.

Year 2021



It gives the impression that these two elements have been clipped together by the wood piece. The wood and the upholstery of the piece can be customised.

Finishes

Wood

Dark Stained Walnut
Grey Stained Walnut
Natural Walnut
White Oak

Upholstery Standard Collection

Cocò
Cotton
Velvet

Upholstery Premium Collection

Nativo
Panama
Bouclé Mélange
Soft Bouclé

Upholstery Special Collection

Leather
Nabuk
Bouclé

Dimensions

88 W x 85 D x 42 seat H. Back H 78



Upholstery. Pearl Bush Bouclé

Wood. Dark Stained Walnut

01



Upholstery. Pearl Bush Bouclé

Wood. Dark Stained Walnut

02

03



04



05



Clip Lounge Chair

Year 2021

W. Width D. Depth S.H. Seat Height B.H. Backrest Height

Dimensions

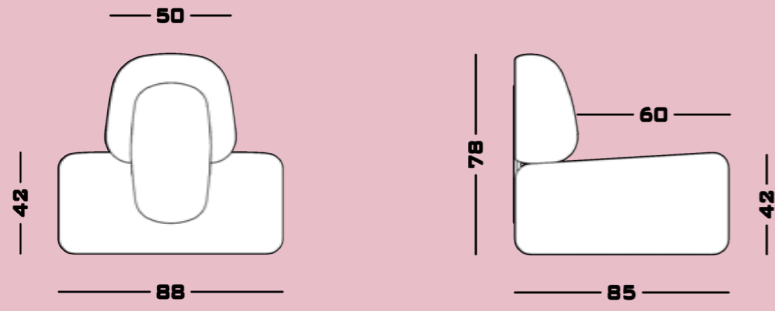

Cod. CLIP

W.	88
D.	85
S.H.	42
B.H.	78



We believe that storytelling through design has the power to shape and change our world. We believe in a more creative future.

Horizon Sofa

Horizon Sofa

Year 2019



The Horizon sofa has been designed with a loose circular backrest. It rests on a metal frame allowing it to be rolled from one side to the other. Both the seat and the back can be upholstered in a number of different fabrics.

The back can be upholstered in two opposing fabrics meaning the appearance of the backrest can be changed daily. The frame is available in a number of metal finishes including polished and satin variations.

Finishes

Metal

Satin Aluminium
Satin Brass
Satin Bronze
Satin Champagne

Polished Aluminium
Polished Brass
Polished Bronze
Polished Champagne

Blue Cenere
Cenere
Jet Black
Off White

Upholstery Standard Collection

Cocò
Cotton
Velvet

Upholstery Premium Collection

Nativo
Panama
Bouclé Mélange
Soft Bouclé

Upholstery Special Collection

Leather
Nabuk
Bouclé

Dimensions

180 W x 75 D x 42 seat H. Back H 100

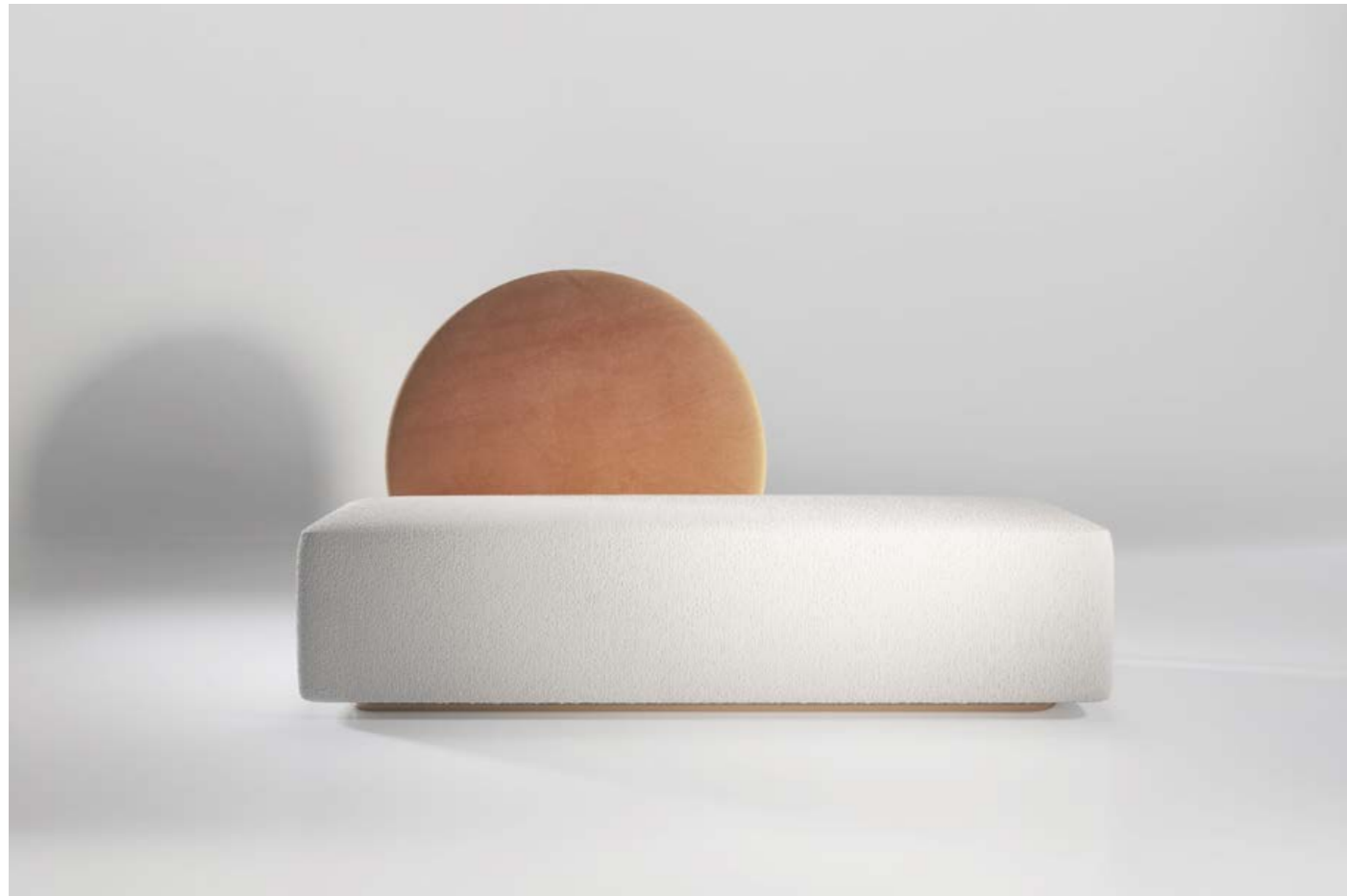

Upholstery. Pearl Bush Bouclé

Upholstery. Raw Sienna

01



Upholstery. Pearl Bush Bouclé

Upholstery. Raw Sienna

Metal. Satin Brass

02



03



04



05

Horizon Sofa

Year 2019

W. Width D. Depth S.H. Seat Height B.H. Backrest Height

Dimensions

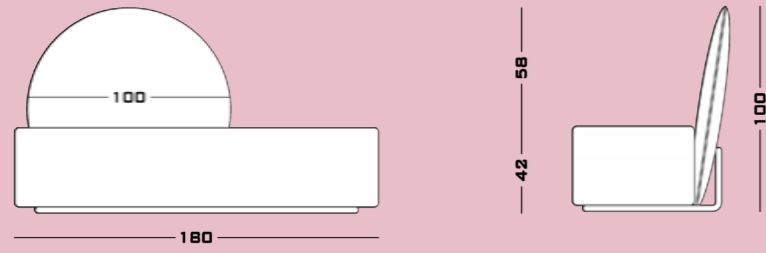

Cod. HRZ

W.	180
D.	75
S.H.	42
B.H.	100



We believe that storytelling through design has the power to shape and change our world. We believe in a more creative future.

Pop Lounge Chair

Pop Lounge Chair

Year 2019



The Pop chair is a lounge chair imagined in its most simple form. Isolating the seat and the back and connecting them with a single metal piece. The clean profile is striking in its simplicity as well as allowing it to slip seamlessly into elegant interiors.

The whole chair has a metal base that continues from the backrest. The backrest is designed to allow a small amount of flex for added comfort. Pop chair is available in a number of different materials, finishes and combinations.

Finishes

Metal

Satin Aluminium
Satin Brass
Satin Bronze
Satin Champagne

Polished Aluminium
Polished Brass
Polished Bronze
Polished Champagne

Blue Cenere
Cenere
Jet Black
Off White

Upholstery Standard Collection

Cocò
Cotton
Velvet

Upholstery Premium Collection

Nativo
Panama
Bouclé Mélange
Soft Bouclé
Suede

Upholstery Special Collection

Leather
Nabuk
Bouclé

Dimensions

60 W x 65 D x 42 seat H. Back H 100



Upholstery. Bone Velvet

Metal. Satin Brass

01



Upholstery. Bone Velvet

Metal. Satin Brass

02

03



04



05



Pop Lounge Chair

Year 2019

W. Width D. Depth S.H. Seat Height B.H. Backrest Height

Dimensions

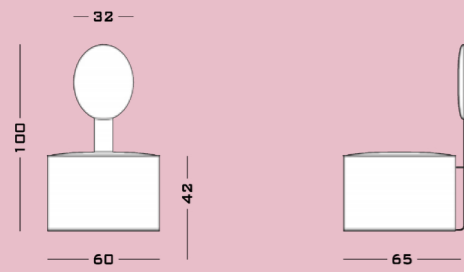

Cod. POP

W.	60
D.	65
S.H.	42
B.H.	100



We believe that storytelling through design has the power to shape and change our world. We believe in a more creative future.

Richmond Lounge Chair

Richmond Lounge Chair

Year 2021



The Richmond lounge chair is a continuation of the Richmond range. This time in Lounge Chair form, the Richmond chair features a curved backrest designed to cradle the user and a soft, upholstered seat for added comfort.

Both the seat and back are fully upholstered and supported by a wooden frame. Both the back and seat can be upholstered in any fabric including COM and the wood is available in a number of finishes.

Finishes

Wood

Dark Stained Walnut
Grey Stained Walnut
Natural Walnut
White Oak

Upholstery Standard Collection

Cocò
Cotton
Velvet

Upholstery Premium Collection

Nativo
Panama
Bouclé Mélange
Soft Bouclé
Suede

Upholstery Special Collection

Leather
Nabuk
Bouclé

Dimensions

67 W x 67 D x 42 seat H. Back H 78



Upholstery. Pearl Bush Bouclé

Wood. Dark Stained Walnut

01



Upholstery. Pearl Bush Bouclé

Wood. Dark Stained Walnut

02

03



04



05

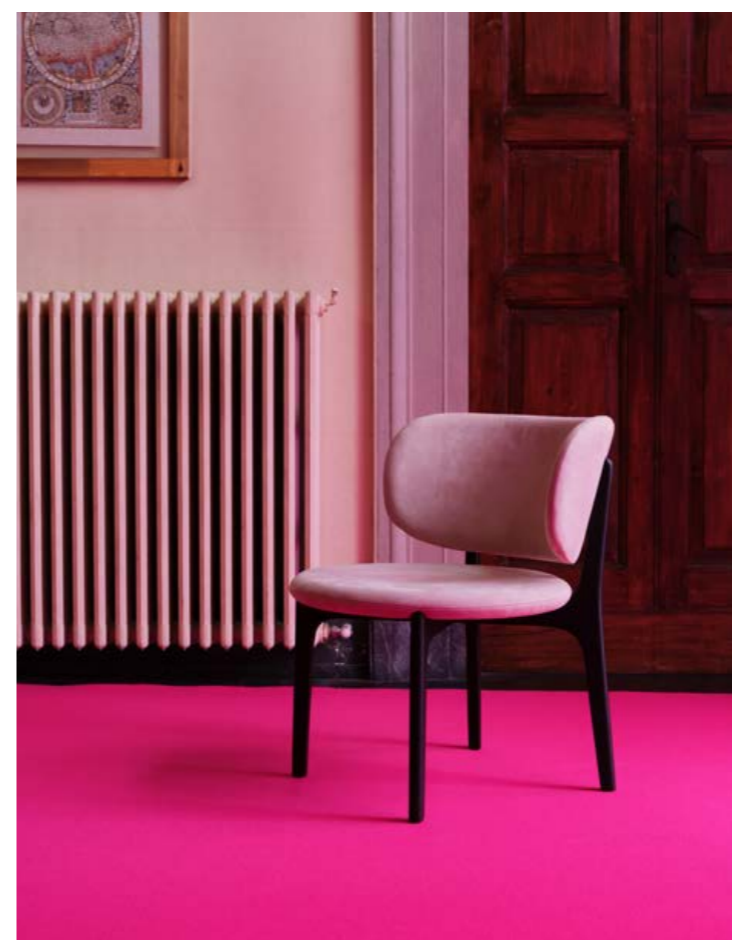

Richmond Lounge Chair

Year 2021

W. Width D. Depth S.H. Seat Height B.H. Backrest Height

Dimensions

Cod. RICHL

W.	67
D.	67
S.H.	42
B.H.	78

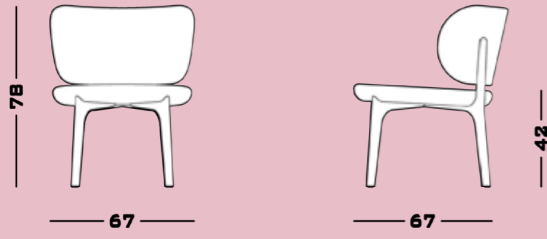



We believe that storytelling through design has the power to shape and change our world. We believe in a more creative future.

Chapter Two

Sofa

Chapter Two Sofa

Chapter Two is a love seat inspired by the soft curves and comfort of B15Z and Tateyama. Two identical backs face opposite ways meaning Chapter Two can and should be used from both sides.

Year 2021



This piece suits retail spaces or home dressing rooms as well as informal living spaces.

Finishes

Metallic Effect

Satin Aluminium
Satin Brass
Satin Bronze
Satin Champagne

Polished Aluminium
Polished Brass
Polished Bronze
Polished Champagne

Blue Cenere
Cenere
Jet Black
Off White

Upholstery Standard Collection

Cocò
Cotton
Velvet

Upholstery Premium Collection

Nativo
Panama
Bouclé Mélange
Soft Bouclé

Upholstery Special Collection

Leather
Nabuk
Bouclé

Dimensions

196 W x 100 D x 42 seat H. Back H 72



Upholstery. Pearl Bush Bouclé

Metallic Effect. Satin Brass

01



Upholstery. Pearl Bush Bouclé

Metallic Effect. Satin Brass

02

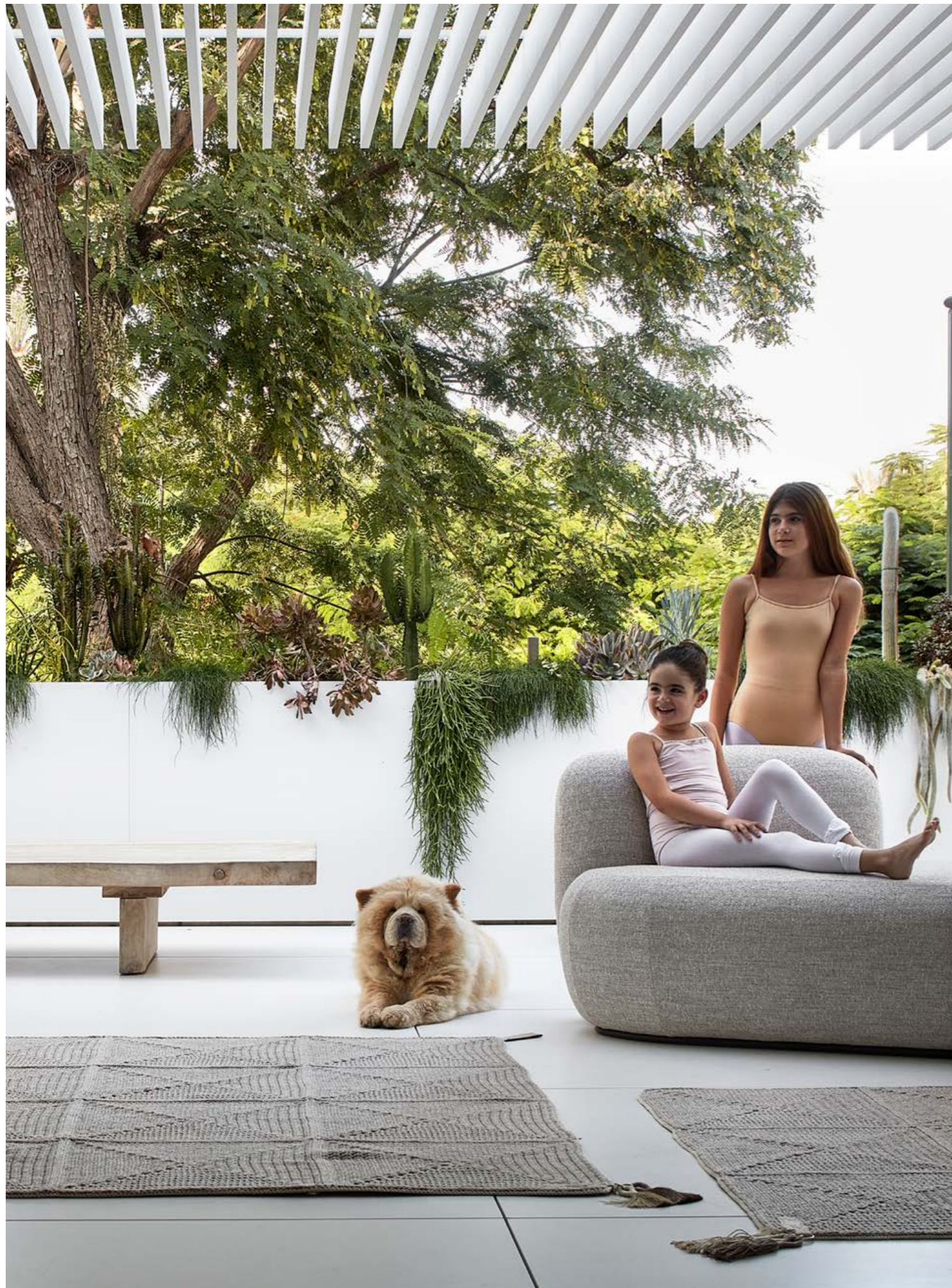

03



04



05

Chapter Two Sofa

Year 2021

W. Width D. Depth S.H. Seat Height B.H. Backrest Height

Dimensions

Cod. CPT

W. 196
D. 100
S.H. 42
B.H. 72

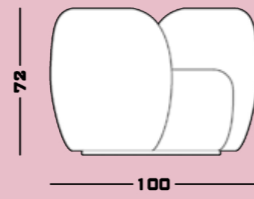
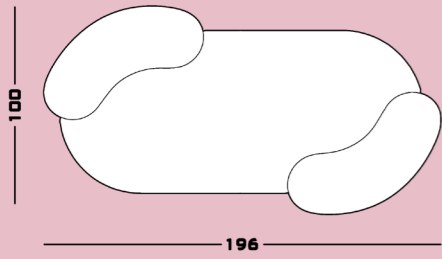



We believe that storytelling through design has the power to shape and change our world. We believe in a more creative future.

Archi Sofa

Archi Sofa

Year 2019



A modular sofa designed as a response to a staple of Romanesque Architecture. Designed to subtly explore the contrast between the inside and outside of a sofa, the outer sides are square and sharp, whereas the

inside corners are smooth and curve inwards, inviting you to enjoy the comfort of the soft fabric. The simple form of Archi Sofa allows it to complement any interior effortlessly.

Finishes

Upholstery Standard Collection

Cocò
Cotton
Velvet

Upholstery Premium Collection

Nativo
Panama
Bouclé Mélange
Soft Bouclé

Upholstery Special Collection

Leather
Nabuk
Bouclé

Dimensions

130 W x 95 D x 42 seat H. Back H 75
190 W x 95 D x 42 seat H. Back H 75
260 W x 95 D x 42 seat H. Back H 75
330 W x 95 D x 42 seat H. Back H 75



Upholstery. Bone Velvet

01



Upholstery. Taupe Brown Velvet

02

03



04



05



Archi Sofa

Year 2019

W. Width D. Depth S.H. Seat Height B.H. Backrest Height

Dimensions

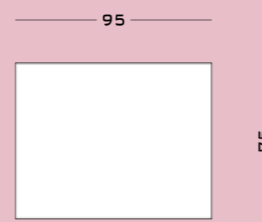
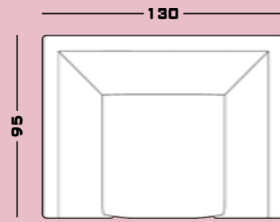

Cod. ARC1SB

W. 130
D. 95
S.H. 42
B.H. 75

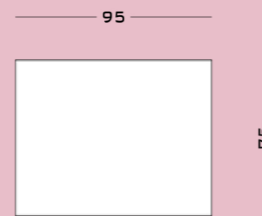
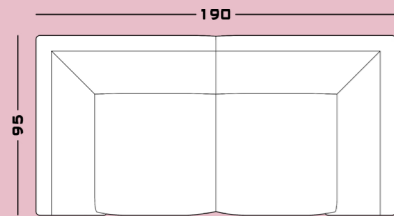

Cod. ARC2S

W. 190
D. 95
S.H. 42
B.H. 75

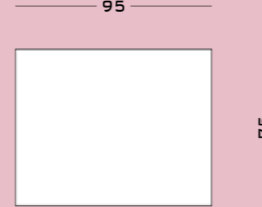
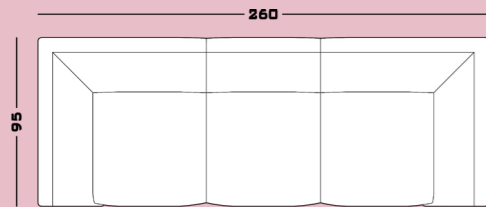

Cod. ARC3S

W. 260
D. 95
S.H. 42
B.H. 75

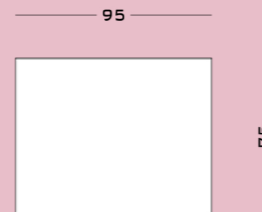
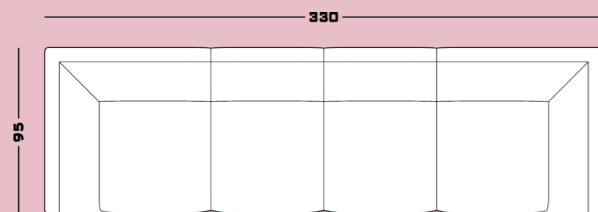

Cod. ARC4S

W. 330
D. 95
S.H. 42
B.H. 75

100.Pingu Side Table / **104.**Pingu X Side Table / **108.**Laghi Monochrome /
112.Laghi Coffee Tables / **116.**Hiri Coffee Table / **120.**Hiri Side Table /
124.Kawa Coffee Tables / **128.**Fragment Coffee Tables / **132.**Gemini Round Coffee Tables /
136.Gemini Soft Hex Coffee Tables / **140.**Book 1 & 2 Coffee Tables /
144.Tayma Coffee Table / **148.**Tayma X Coffee Table / **152.**Arris Coffee Table /
156.Arris Side Table / **160.**Lock Side Table / **164.**Pangea Coffee Table /
168.Taras Coffee Table / **172.**Atlante Side Table / **176.**Origin Side Table /
180.Sketch Side Table / **184.**Orion Side Table

Coffee & Side Tables



We believe that storytelling through design has the power to shape and change our world. We believe in a more creative future.

Pingu Side Table

Pingu Side Table

Pingu is a playful addition to any room, offering up a place for a drink or an ashtray beside your chair. An inverted dome is supported by a soft-shaped base which it is barely touching.

Year 2020



A metal top adds a touch of class. Pingu is available in any RAL colour in high gloss or matte finishes. The metal is available in any metal finish including both brushed and polished versions.

Finishes

Metal

Satin Aluminium
Satin Brass
Satin Bronze
Satin Champagne

Polished Aluminium
Polished Brass
Polished Bronze
Polished Champagne

Blue Cenere
Cenere
Jet Black
Off White

Wood

Lacquered

Lacquered Matte
Lacquered Glossy

Dimensions

35 W x 46 D x 53 H. Top Dia 35



Lacquered. Pearl Orange Glossy

Metal. Satin Brass

01



Lacquered. Pearl Orange Glossy

Metal. Polished Brass

02



Pingu Side Table

Year 2020

W. Width D. Depth H. Height T.D. Top Diameter

Dimensions

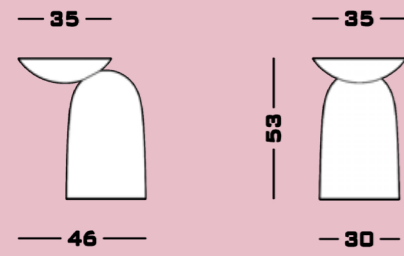

Cod. PINGU

W.	35
D.	46
H.	53
T.D.	35



We believe that storytelling through design has the power to shape and change our world. We believe in a more creative future.

Pingu X Side Table

Pingu X Side Table

Year 2021



Pingu X is a playful addition to any room, offering up a place for a drink or an ashtray beside your chair. An inverted dome is supported by a soft-shaped base which it is barely touching.

Pingu X is available in standard and premium marble finishes, other marbles are available on request. The metal is available in any metal finish including both brushed and polished versions.

Finishes

Metal

Satin Aluminium
Satin Brass
Satin Bronze
Satin Champagne

Polished Aluminium
Polished Brass
Polished Bronze
Polished Champagne

Blue Cenere
Cenere
Jet Black
Off White

Standard Marble

Arabescato Orobico
Carrara CD
Dark Emperador
Nero Marquina
Travertino Filled
Travertino Open Pore

Premium Marble

Calacatta
Fior Di Pesco
Rosso Levanto
Verde Alpi

Dimensions

35 W x 46 D x 53 H. Top Dia 35



Marble. Calacatta

Marble. Verde Alpi

01



Marble. Calacatta

Metal. Polished Brass

02

03



04



05



Pingu X Side Table

Year 2021

W. Width D. Depth H. Height T.D. Top Diameter

Dimensions

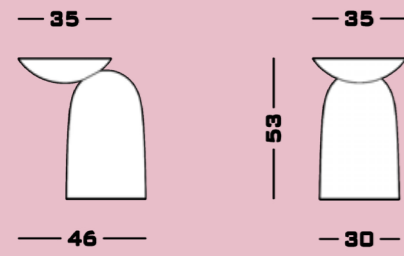

Cod. PINGUX

W. 35
D. 46
H. 53
T.D. 35



We believe that storytelling through design has the power to shape and change our world. We believe in a more creative future.

Laghi Monochrome

Laghi Monochrome

The Laghi Monochrome Coffee Tables are a group of low coffee tables, each in the shape of a body of water and inspired by the peacefulness and beauty of the Lake District in United Kingdom.

Year 2021



Smooth curves from the top down to the base add to the idea and aesthetic of flowing water and peacefulness. The tables can be lacquered in any RAL colour and the tables are available as individuals or as a complete set.

Finishes

Wood Lacquered

Lacquered Matte
Lacquered Glossy

Dimensions

71 W x 52 D x 30 H
84 W x 55 D x 30 H
130 W x 80 D x 30 H



Wood Lacquered. Tiglio Glossy

01



Wood Lacquered. Tiglio Matte

02

03



04

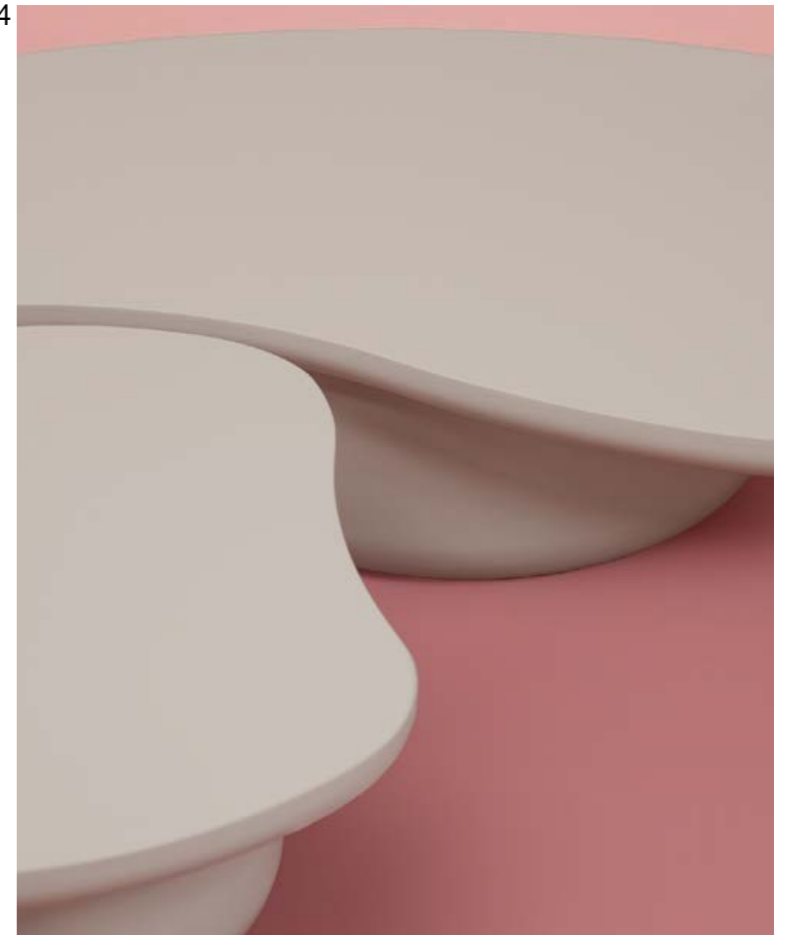

05



Laghi Monochrome

Year 2021

W. Width D. Depth H. Height

Dimensions

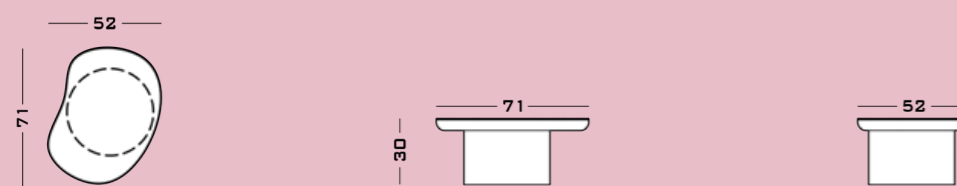

Cod. LAGHILACS

W. 71
D. 52
H. 30

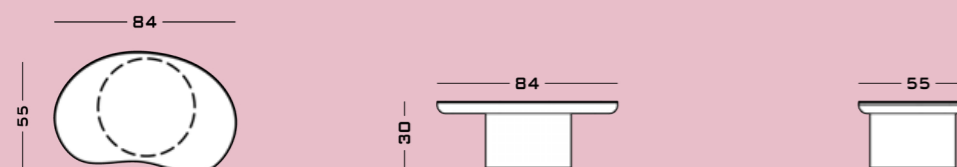

Cod. LAGHILACM

W. 84
D. 55
H. 30

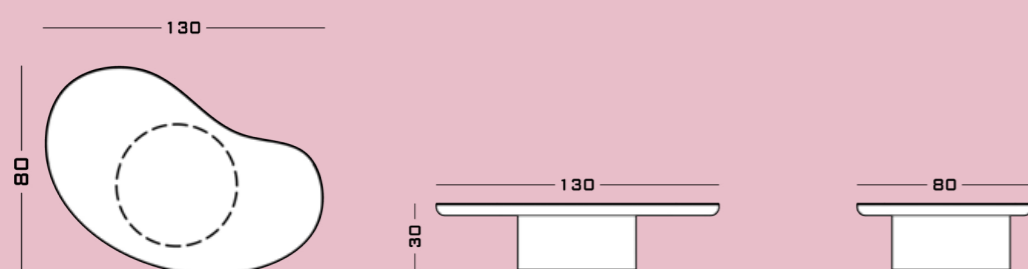

Cod. LAGHILACL

W. 130
D. 80
H. 30



We believe that storytelling through design has the power to shape and change our world. We believe in a more creative future.

Laghi Coffee Tables

Laghi Coffee Tables

The Laghi Coffee Tables are a group of low coffee tables, each in the shape of a body of water and inspired by the peacefulness and beauty of the Lake District in United Kingdom. Each table is topped with a piece of 5mm extra-clear glass mirror.

Year 2021



Smooth curves from the top down to the base add to the idea and aesthetic of flowing water and peacefulness. The base can be lacquered in any RAL colour and the tables are available as individuals or as a complete set.

Finishes

Wood Lacquered

Lacquered Matte
Lacquered Glossy

Mirror

Extra-clear Mirror

Dimensions

71 W x 52 D x 30 H
84 W x 55 D x 30 H
130 W x 80 D x 30 H



Wood Lacquered. Blue Cenere Matte

Mirror. Extra-clear Mirror

01



Wood Lacquered. Tortora Matte

Mirror. Extra-clear Mirror

02



03



04

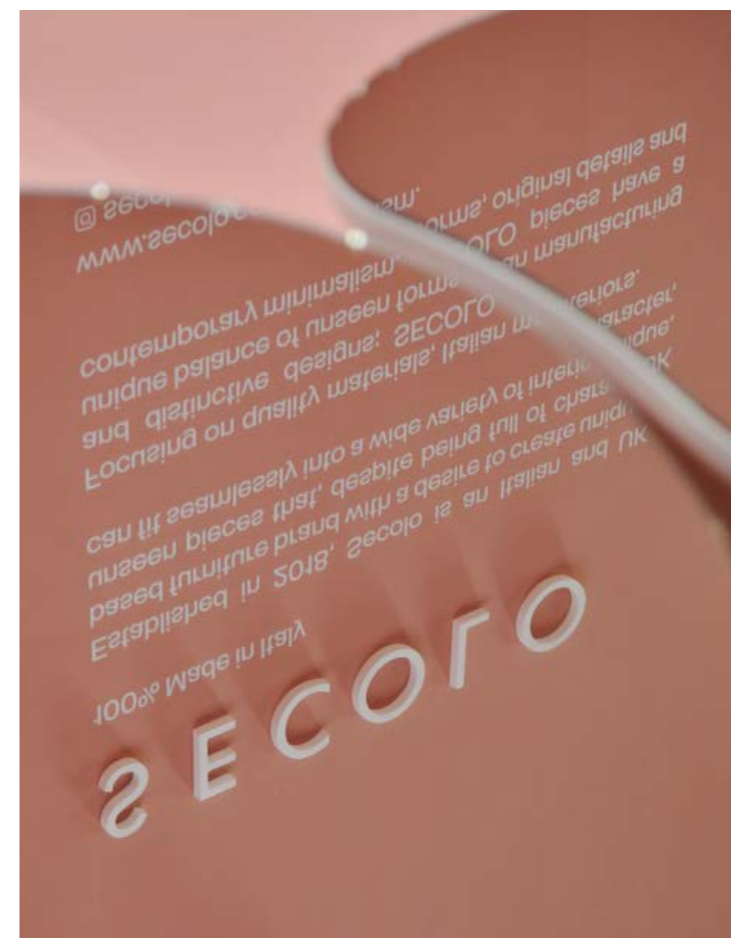

05

Laghi Coffee Tables

Year 2021

W. Width D. Depth H. Height

Dimensions

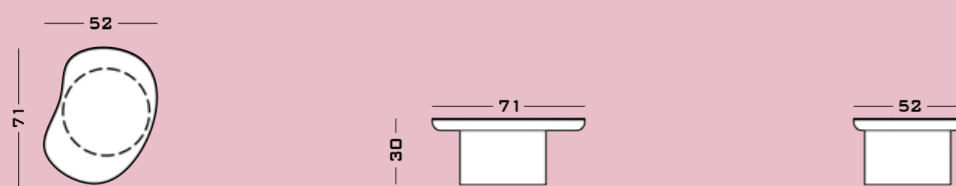

Cod. LAGHIS

W. 71
D. 52
H. 30

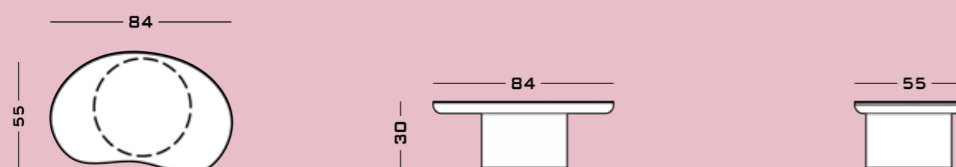

Cod. LAGHIM

W. 84
D. 55
H. 30

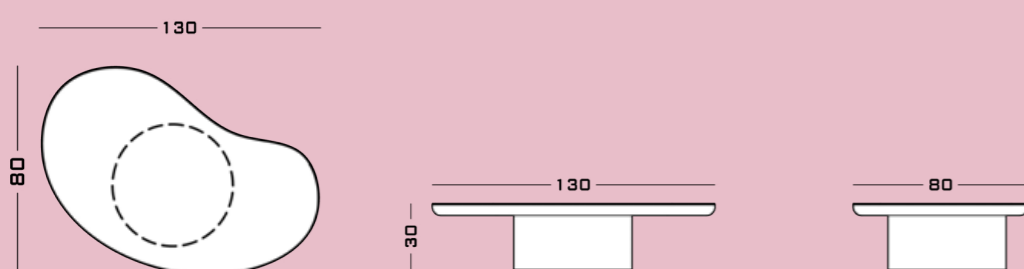

Cod. LAGHIL

W. 130
D. 80
H. 30



We believe that storytelling through design has the power to shape and change our world. We believe in a more creative future.

Hiri Coffee Table

Hiri Coffee Table

Hiri coffee tables are characterized by their asymmetrical, even accidental forms. Those 'accidental' forms are contrasted by deliberate and meticulous detailing in leather. Each piece being entirely upholstered as if to protect and preserve the discovered form.

Year 2024



The many faces of the tables, each one accentuated by tone-on-tone stitching, come together to create something surprising that breaks convention. Hiri coffee and side tables are available in any of our leather options.

Finishes

Upholstery Special Collection

Leather

Dimensions

131 W x 73 D x 35 H



Upholstery. Soul White Leather

01



Upholstery. Soul White Leather

02

03



04



05



Hiri Coffee Table

Year 2024

W. Width D. Depth H. Height

Dimensions

Cod. HIRIC

W. 131

D. 73

H. 35

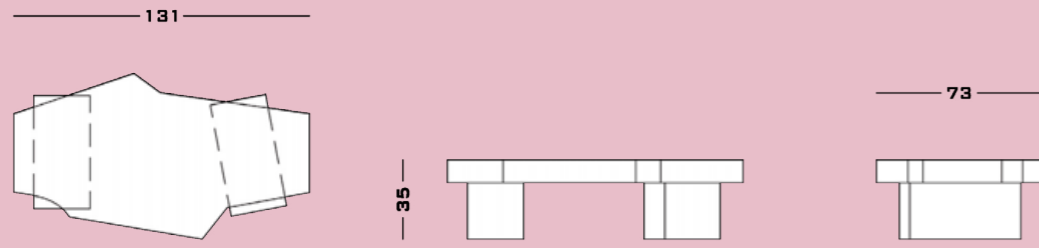



We believe that storytelling through design has the power to shape and change our world. We believe in a more creative future.

Hiri Side Table

Hiri Side Table

Year 2024



Hiri side table is characterized by its asymmetrical, even accidental forms. Those 'accidental' forms are contrasted by deliberate and meticulous detailing in leather. Each piece being entirely upholstered as if to protect and preserve the discovered form.

The many faces of the tables, each one accentuated by tone-on-tone stitching, come together to create something surprising that breaks convention. Hiri coffee and side tables are available in any of our leather options.

Finishes

Upholstery
Special
Collection

Leather

Dimensions

49 W x 30 D x 40 H



Upholstery. Soul White Leather

01



Upholstery. Soul White Leather

02

03



04



05



Hiri Side Table

Year 2024

W. Width D. Depth H. Height

Dimensions

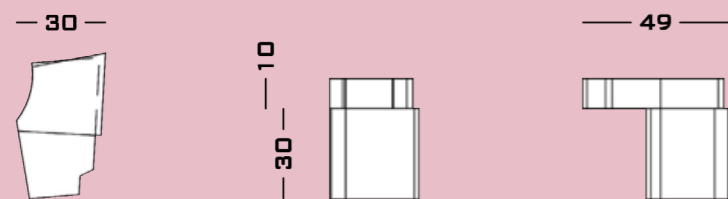

Cod. HIRIS

W.	49
D.	30
H.	40



We believe that storytelling through design has the power to shape and change our world. We believe in a more creative future.

Kawa Coffee Tables

Kawa Coffee Tables

Year 2024



When a pebble is found on the beach, it's shape and texture tells the story of 1000 years. KAWA Coffee Tables are characterised by the same smooth, soft shapes that nature itself creates, perfectly coated and preserved at this point in time.

The two tables act individually or as one to give added flexibility and functionality. KAWA coffee tables are customisable in a variety of lacquered and stained wood options.

Finishes

Wood Lacquered

Lacquered Matte
Lacquered Glossy

Wood

Dark Stained Walnut
Grey Stained Walnut
Natural Walnut
White Oak

Dimensions

Major: 102 W x 122,5 D x 35 H
Minor: 60,5 W x 95 D x 35 H



Wood Lacquered. Tortora Glossy

Wood. Natural Walnut

01



Wood Lacquered. Tortora Glossy

Wood. Natural Walnut

02

03



Kawa Coffee Tables

Year 2024

W. Width D. Depth H. Height

Dimensions

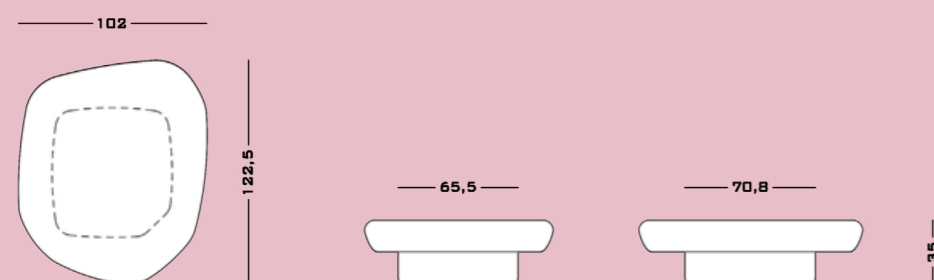

Cod. KAWAJ

W. 102
D. 122,5
H. 35

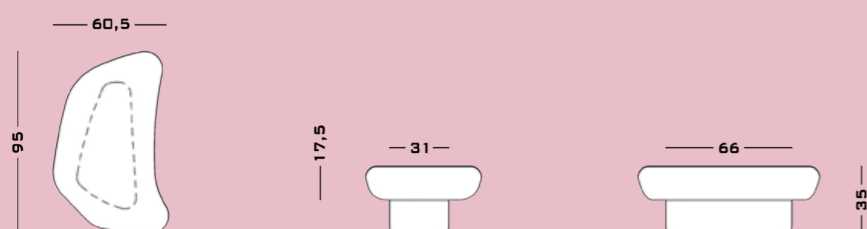

Cod. KAWAN

W. 60,5
D. 95
H. 35



We believe that storytelling through design has the power to shape and change our world. We believe in a more creative future.

Fragment Coffee Tables

Fragment Coffee Tables

Year 2022



Fragments of an undisclosed time. Irregular pieces of natural stone framed and supported by a metal base. The Fragment coffee tables are a set of three

customisable tables at different heights. Available in a number of stone and metal finishes as well as any RAL colour.

Finishes

Metal

Satin Aluminium
Satin Brass
Satin Bronze
Satin Champagne

Polished Aluminium
Polished Brass
Polished Bronze
Polished Champagne

Blue Cenere
Cenere
Jet Black
Off White

Standard Marble

Arabescato Orobico
Carrara CD
Dark Emperador
Nero Marquina
Travertino Filled
Travertino Open Pore

Premium Marble

Calacatta
Fior Di Pesco
Rosso Levanto
Verde Alpi

Dimensions

Model S: 85 W x 79 D x 50 H
Model M: 87 W x 97 D x 40 H
Model L: 122 W x 96 D x 35 H



Marble. Travertino Open Pore

Metal. Satin Bronze

01



Marble. Calacatta & Rosso Levanto

Metal. Satin Aluminium

02

03



04



05



Fragment Coffee Tables

Year 2022

W. Width D. Depth H. Height

Dimensions

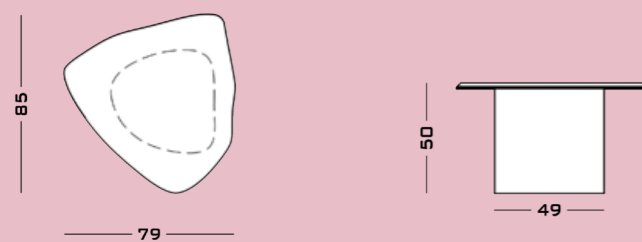

Cod. FRGS

W. 79
D. 85
H. 50

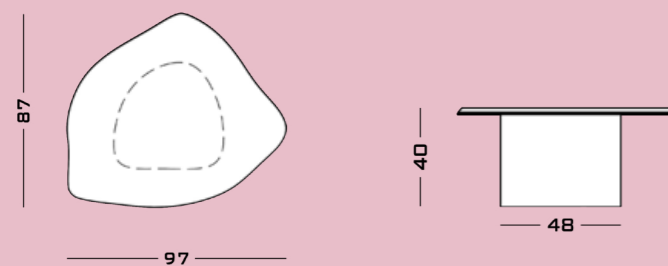

Cod. FRGM

W. 97
D. 87
H. 40

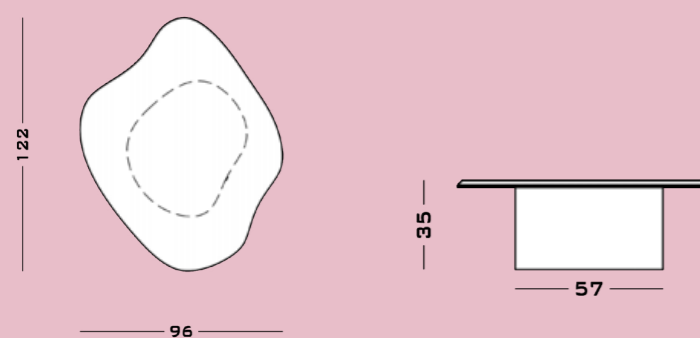

Cod. FRGL

W. 96
D. 122
H. 35



We believe that storytelling through design has the power to shape and change our world. We believe in a more creative future.

Gemini Round Coffee Tables

Gemini Round Coffee Tables

Year 2021



The Gemini Coffee Tables are characterised by the combination of materials on the top and bottom of the table. Leather wraps around the entire base and even continues up the underside of the table top. Half way around the top the leather stops and the table is

finished by a marble top with a perfectly curved edge which mirrors the curve of the leather. The Gemini Tables are available in either a round or soft-hex top and in a variety of stone and leather combinations.

Finishes

Standard Marble

Arabescato Orobico
Carrara CD
Dark Emperador
Nero Marquina
Travertino Filled
Travertino Open Pore

Premium Marble

Calacatta
Fior Di Pesco
Rosso Levanto
Verde Alpi

Upholstery Premium Collection

Suede

Upholstery Special Collection

Leather

Dimensions

Minor: 50 Dia x 50 H
Major: 64.5 Dia x 40 H



Upholstery. Steel Bird Leather

Marble. Calacatta

01



Upholstery. Steel Bird Leather

Marble. Calacatta

02

03



04



05



Gemini Round Coffee Tables

Year 2021

T.D. Top Diameter B.D. Base Diameter H. Height

Dimensions

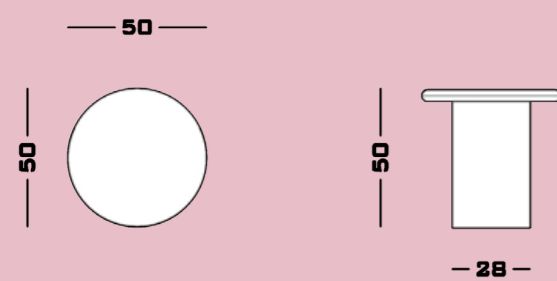

Cod. GEMR50

T.D. 50
B.D. 28
H. 50

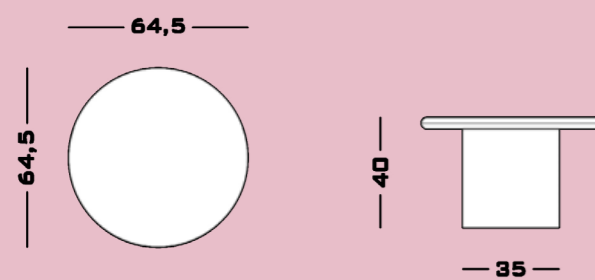

Cod. GEMR64

T.D. 64.5
B.D. 35
H. 40



We believe that storytelling through design has the power to shape and change our world. We believe in a more creative future.

Gemini Soft Hex Coffee Tables

Gemini Soft Hex Coffee Tables

Year 2021



The Gemini Coffee Tables are characterised by the combination of materials on the top and bottom of the table. Leather wraps around the entire base and even continues up the underside of the table top. Half way around the top the leather stops and the table is

finished by a marble top with a perfectly curved edge which mirrors the curve of the leather. The Gemini Tables are available in either a round or soft-hex top and in a variety of stone and leather combinations.

Finishes

Standard Marble

Arabescato Orobico
Carrara CD
Dark Emperador
Nero Marquina
Travertino Filled
Travertino Open Pore

Premium Marble

Calacatta
Fior Di Pesco
Rosso Levanto
Verde Alpi

Upholstery Premium Collection

Suede

Upholstery Special Collection

Leather

Dimensions

Minor: 58 W x 42 D x 45 H
Major: 74 W x 53 D x 35 H



Upholstery. Terragon Leather

Marble. Calacatta

01



Upholstery. Terragon Leather

Marble. Calacatta

02

03



04



05



Gemini Soft Hex Coffee Tables

Year 2021

W. Width D. Depth H. Height

Dimensions

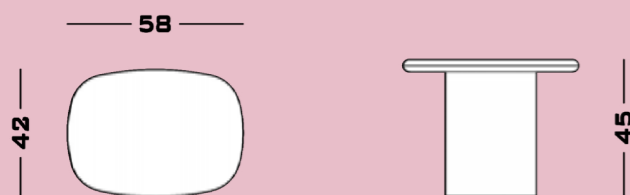

Cod. GEMS58

W. 58
D. 42
H. 45

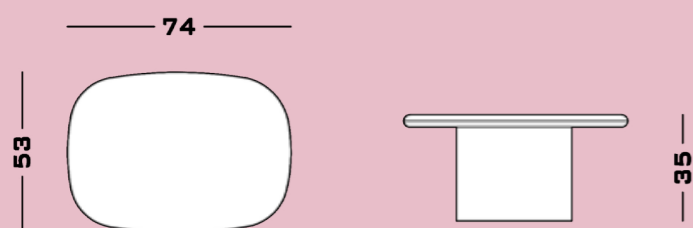

Cod. GEMS74

W. 74
D. 53
H. 35



We believe that storytelling through design has the power to shape and change our world. We believe in a more creative future.

Book 1 & 2

Coffee Tables

Book 1 & 2 Coffee Tables

Year 2019



Two sizes of coffee table in the shape of two giant leaves. The veins of the book-matched marble mirror the veins of a leaf.

Available in various marbles and natural stones as well as different metal finishes.

Finishes

Metal

Blue Cenere
Cenere
Jet Black
Off White

Standard Marble

Arabescato Orobico
Carrara CD
Dark Emperador
Nero Marquina
Travertino Filled
Travertino Open Pore

Premium Marble

Calacatta
Fior Di Pesco
Rosso Levanto
Verde Alpi

Dimensions

Book 2: 72 W x 38 D x 30 H
Book 1: 105 W x 55 D x 40 H



Marble. Arabescato Orobico

Marble. Calacatta

Metal. Jet Black

01



Marble. Arabescato Orobico

Marble. Calacatta

02

03

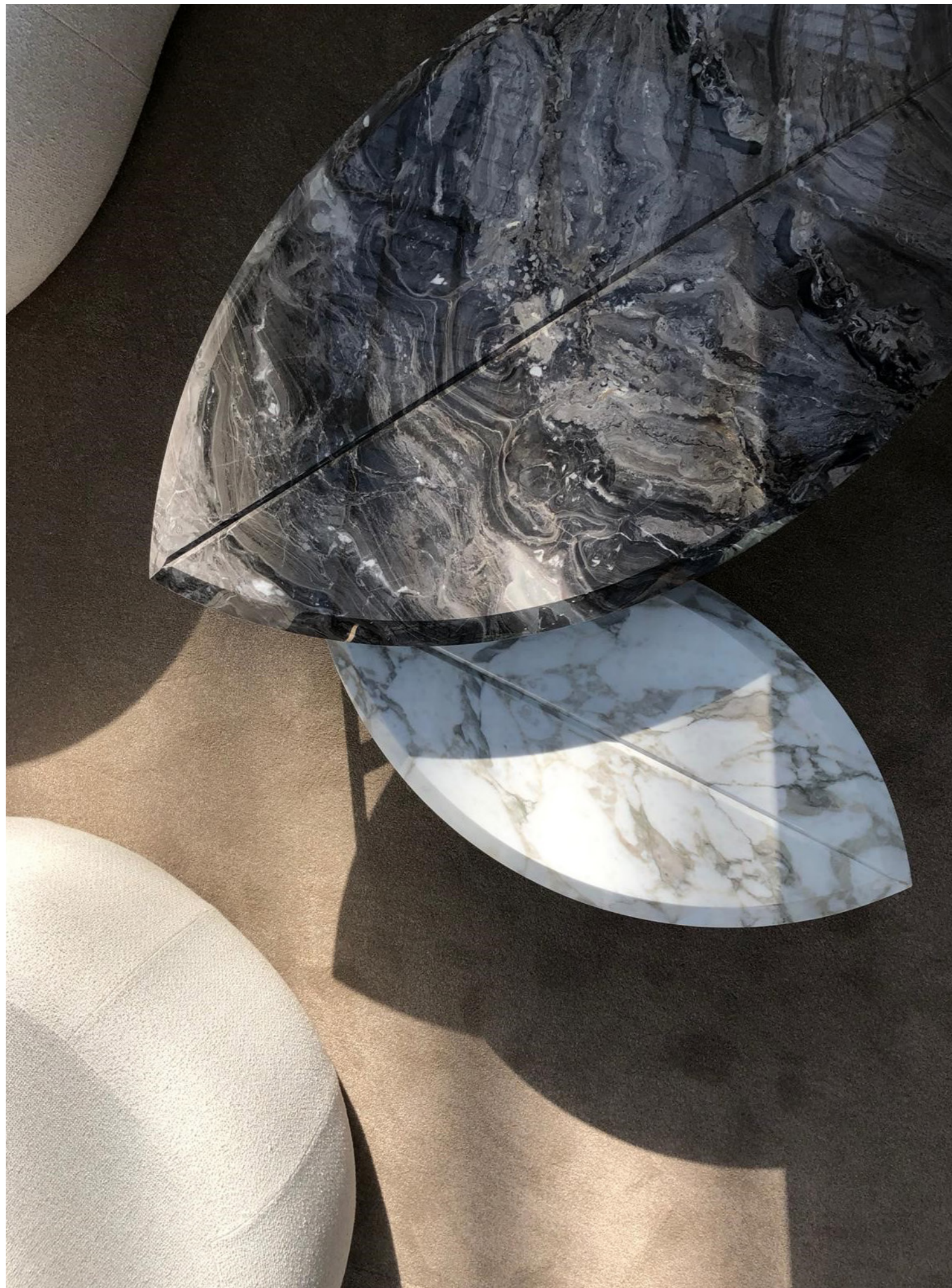

04



05



Book 1 & 2 Coffee Tables

Year 2019

W. Width D. Depth H. Height

Dimensions

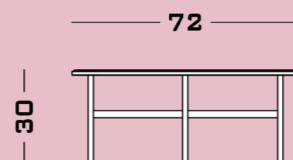
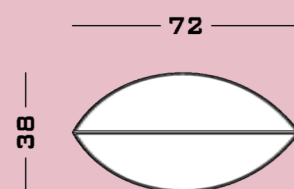

Cod. BOOKII

W. 72
D. 38
H. 30

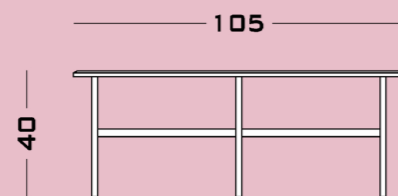
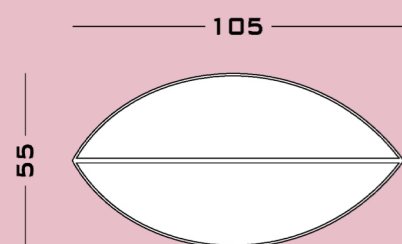

Cod. BOOKI

W. 105
D. 55
H. 40



We believe that storytelling through design has the power to shape and change our world. We believe in a more creative future.

Tayma Coffee Table

Tayma Coffee Table

Year 2023



Sometimes a shift occurs, seemingly impossible, no one knows when and no one knows quite how, yet the result of it will remain for the foreseeable. The Tayma coffee represents one of these shifts.

Solid stone or wood pieces have been perfectly cut to reveal a metallic detail. Tayma comes in both stone and lacquered wood options and in a high gloss or matte finish.

Finishes

Metal

Satin Aluminium
Satin Brass
Satin Bronze
Satin Champagne

Polished Aluminium
Polished Brass
Polished Bronze
Polished Champagne

Blue Cenere
Cenere
Jet Black
Off White

Wood

Lacquered

Lacquered Matte
Lacquered Glossy

Dimensions

165 W x 70 D x 35 H



Wood Lacquered. Window Grey Glossy Metal. Satin Brass

01



Wood Lacquered. Window Grey Glossy Metal. Satin Brass

02

03



04



Tayma Coffee Table

Year 2023

W. Width D. Depth H. Height

Dimensions

Cod. TAYMA

W. 165

D. 70

H. 35

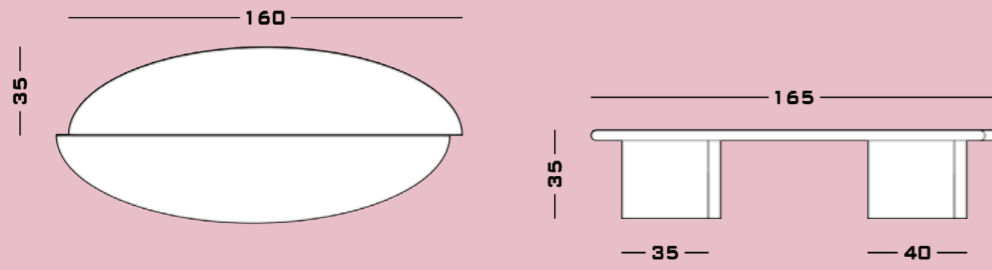



We believe that storytelling through design has the power to shape and change our world. We believe in a more creative future.

Tayma X Coffee Table

Tayma X Coffee Table

Year 2023



Sometimes a shift occurs, seemingly impossible, no one knows when and no one knows quite how, yet the result of it will remain for the foreseeable. The Tayma coffee represents one of these shifts.

Solid stone or wood pieces have been perfectly cut to reveal a metallic detail. Tayma X comes in both standard and premium marble and stone options.

Finishes

Metal

Satin Aluminium
Satin Brass
Satin Bronze
Satin Champagne

Polished Aluminium
Polished Brass
Polished Bronze
Polished Champagne

Blue Cenere
Cenere
Jet Black
Off White

Standard Marble

Arabescato Orobico
Carrara CD
Dark Emperador
Nero Marquina
Travertino Filled
Travertino Open Pore

Premium Marble

Calacatta
Fior Di Pesco
Rosso Levanto
Verde Alpi

Dimensions

165 W x 70 D x 35 H



Marble. Travertino Open Pore

Metal. Satin Brass

01



Marble. Travertino Open Pore

Metal. Satin Brass

02



03



04



05

Tayma X Coffee Table

Year 2023

W. Width D. Depth H. Height

Dimensions

Cod. TAYMAX

W. 165

D. 70

H. 35

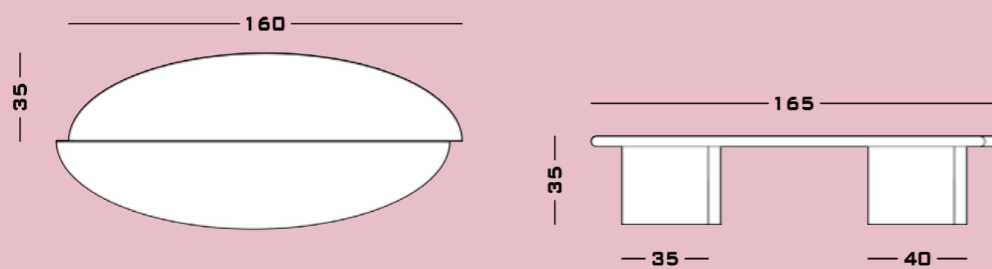



We believe that storytelling through design has the power to shape and change our world. We believe in a more creative future.

Arris Coffee Table

Arris Coffee Table

Year 2023



The Arris collection is an exploration into the lost value of marble and other precious stones. Instead of the stone being the feature of this piece, Arris protects it with a layer of metal, leaving the stone only as a

delicate detail of the piece, visible only from certain angles. Available in both coffee table and side table sizes, Arris is customisable in both the metal and the stone options.

Finishes

Metal

Satin Aluminium
Satin Brass
Satin Bronze
Satin Champagne

Polished Aluminium
Polished Brass
Polished Bronze
Polished Champagne

Blue Cenere
Cenere
Jet Black
Off White

Standard Marble

Arabescato Orobico
Carrara CD
Dark Emperador
Nero Marquina
Travertino Filled
Travertino Open Pore

Premium Marble

Calacatta
Fior Di Pesco
Rosso Levanto
Verde Alpi

Dimensions

120 W x 85 D x 35 H



Metal. Satin Aluminium

Marble. Travertino Open Pore

01



Metal. Satin Aluminium

Marble. Rosso Levanto

02



03



04



05

Arris Coffee Table

Year 2023

W. Width D. Depth H. Height

Dimensions

Cod. ARRISCOF

W. 120

D. 85

H. 39,2

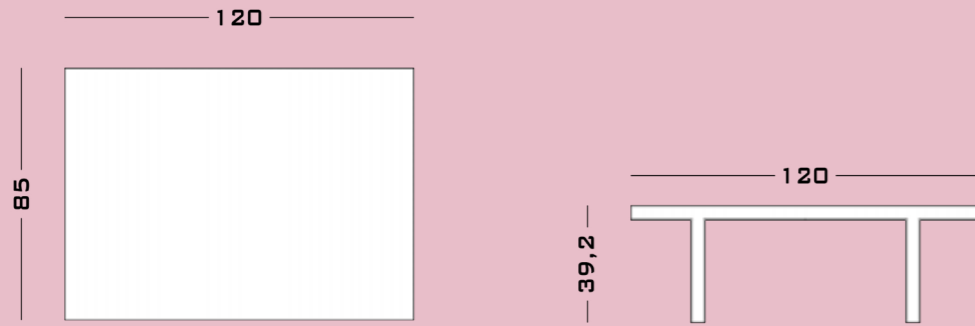



We believe that storytelling through design has the power to shape and change our world. We believe in a more creative future.

Arris Side Table

Arris Side Table

Year 2023



The Arris collection is an exploration into the lost value of marble and other precious stones. Instead of the stone being the feature of this piece, Arris protects it with a layer of metal, leaving the stone only as a

delicate detail of the piece, visible only from certain angles. Available in both coffee table and side table sizes, Arris is customisable in both the metal and the stone options.

Finishes

Metal

Satin Aluminium
Satin Brass
Satin Bronze
Satin Champagne

Polished Aluminium
Polished Brass
Polished Bronze
Polished Champagne

Blue Cenere
Cenere
Jet Black
Off White

Standard Marble

Arabescato Orobico
Carrara CD
Dark Emperador
Nero Marquina
Travertino Filled
Travertino Open Pore

Premium Marble

Calacatta
Fior Di Pesco
Rosso Levanto
Verde Alpi

Dimensions

45 W x 45 D x 45 H



Metal. Satin Aluminium

Marble. Travertino Open Pore

01



Metal. Satin Aluminium

Marble. Rosso Levanto

02

03



04



05



Arris Side Table

Year 2023

W. Width D. Depth H. Height

Dimensions

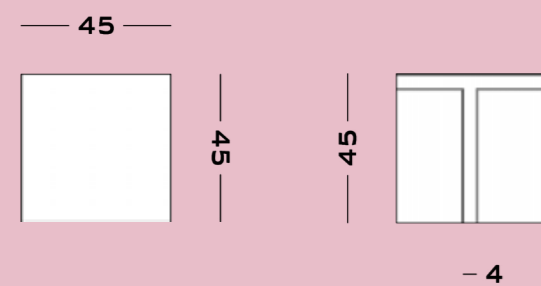

Cod. ARRISSIDE

W. 45
D. 45
H. 45



We believe that storytelling through design has the power to shape and change our world. We believe in a more creative future.

Lock Side Table

Lock Side Table

Year 2023



Lock ignores symmetry and introduces unexpected proportions into the form of a side table. Lock is a side table that works anywhere – the 5 straight edges allow it to perfectly sit next to any other piece at a variety of angles. An extra-thick top challenges the

normal hierarchy of a side table giving a presence that is unique only to Lock. Lock is available in any RAL colour in both matte and high gloss finishes.

Finishes

Wood Lacquered

Lacquered Matte
Lacquered Glossy

Dimensions

38 W x 44 D x 40 H



Wood Lacquered. Red Violet Glossy

01



Wood Lacquered. Red Violet Matte

02

03

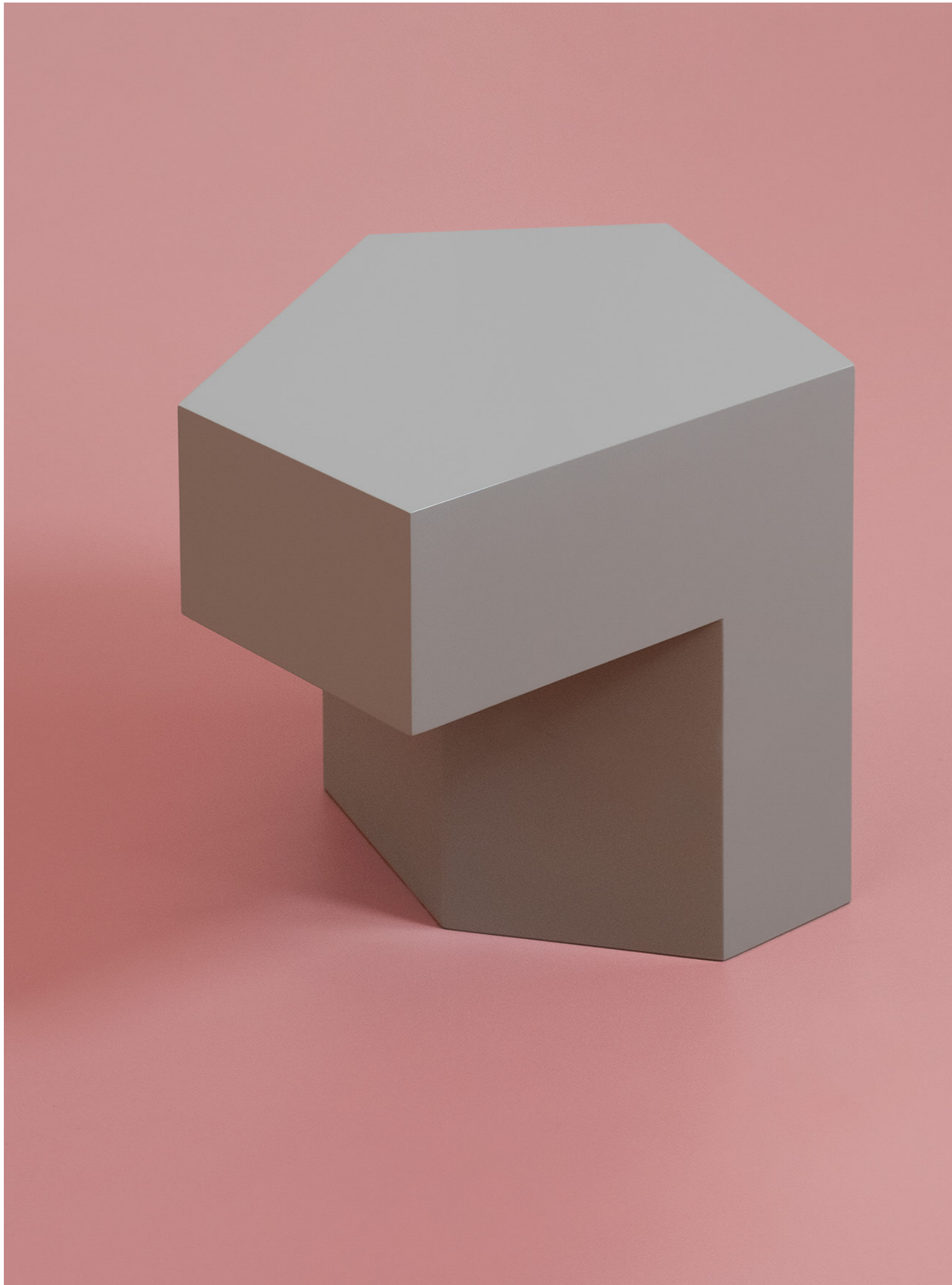

04



05



Lock Side Table

Year 2023

W. Width D. Depth H. Height

Dimensions

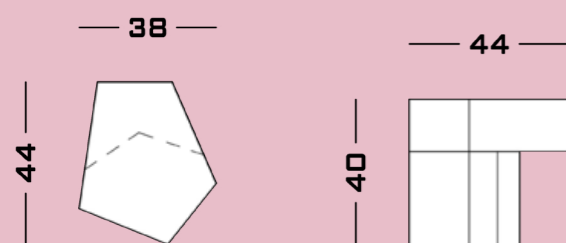

Cod. LOCK

W. 38
D. 44
H. 40



We believe that storytelling through design has the power to shape and change our world. We believe in a more creative future.

Pangea Coffee Table

Pangea Coffee Table

Two coffee tables with only one leg each make up the Pangea Coffee Table. It's monolithic forms make it a fascinating and eye-catching addition to any room.

Year 2021



The table can be used together or seperately, giving the name Pangea. Available in any of our wood finishes.

Finishes

Wood

Dark Stained Walnut
Grey Stained Walnut
Natural Walnut
White Oak

Dimensions

130 W x 75 D x 30 H



Wood. Dark Stained Walnut

01



Wood. Dark Stained Walnut

02

03



04

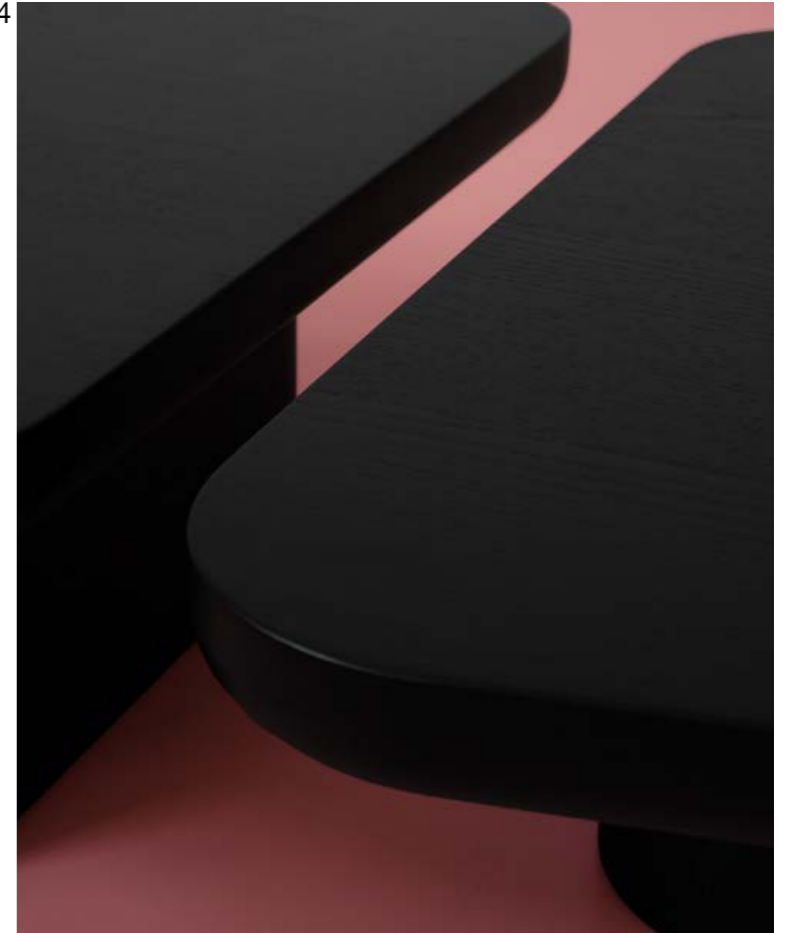

05



Pangea Coffee Table

Year 2021

W. Width D. Depth H. Height

Dimensions

Cod. PNG

W. 130

D. 75

H. 30

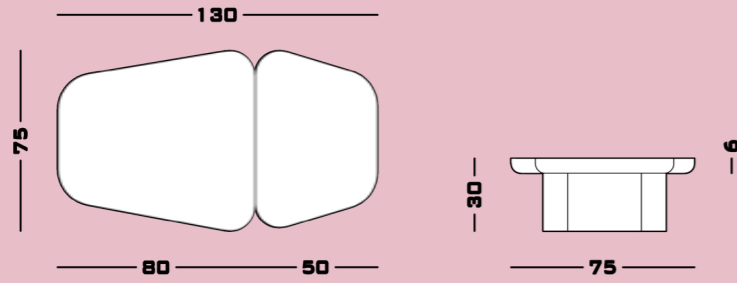



We believe that storytelling through design has the power to shape and change our world. We believe in a more creative future.

Taras Coffee Table

Taras Coffee Table

Year 2021



Named after the two seas of Taranto, the Taras Coffee Table consists of two marble or stone pieces held by another two solid wood slabs. The wooden pieces are

not connected to one another creating a unique and surprising balancing act. Available in different wood, marble and stone combinations.

Finishes

Standard Marble

Arabescato Orobico
Carrara CD
Dark Emperador
Nero Marquina
Travertino Filled
Travertino Open Pore

Premium Marble

Calacatta
Fior Di Pesco
Rosso Levanto
Verde Alpi

Wood

Dark Stained Walnut
Grey Stained Walnut
Natural Walnut
White Oak

Dimensions

155 W x 59 D x 35 H



Wood. Dark Stained Walnut

Marble. Calacatta

01



Wood. Dark Stained Walnut

Marble. Calacatta

02

03



04



05



Taras Coffee Table

Year 2021

W. Width D. Depth H. Height

Dimensions

Cod. TARAS

W. 155
D. 59
H. 35

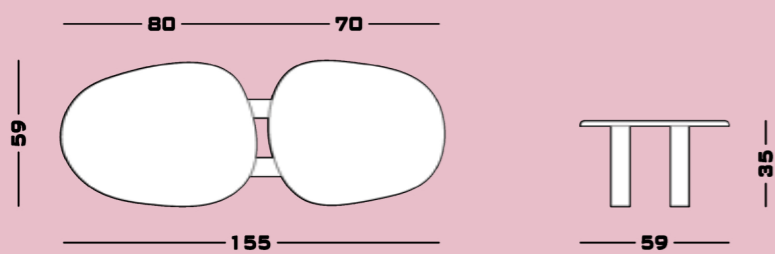



We believe that storytelling through design has the power to shape and change our world. We believe in a more creative future.

Atlante Side Table

Atlante Side Table

The Atlante Side Table is both a coffee table and a bedside table. With a cut sphere creating a large circular top sat upon a square section base creating interesting geometries where they meet.

Year 2021



Within the base there is space for books or whatever objects need to be stored within. Available also with a solid base and in various wood finishes.

Finishes

Wood

Dark Stained Walnut
Grey Stained Walnut
Natural Walnut
White Oak

Dimensions

45 Dia x 35 H



Wood. Dark Stained Walnut

01



Wood. Dark Stained Walnut

02

03



04



Atlante Side Table

Year 2021

T.D. Top Diameter H. Height

Dimensions

— 45 —



— 35 —

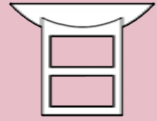

Cod. ATLA

T.D. 45

H. 35



We believe that storytelling through design has the power to shape and change our world. We believe in a more creative future.

Origin Side Table

Origin Side Table

The Origin side tables are designed to showcase the beauty of natural stone. Two pieces of stone meet off-centre with the table top creating an entirely stone construction with no visible joints.

Year 2019



The Origin tables are available in any of our collection of marbles and stones.

Finishes

Standard Marble

Arabescato Orobico
Carrara CD
Dark Emperador
Nero Marquina
Travertino Filled
Travertino Open Pore

Premium Marble

Calacatta
Fior Di Pesco
Rosso Levanto
Verde Alpi

Dimensions

45 Dia x 35 H



Marble. Carrara CD

01



Marble. Carrara CD

Marble. Arabescato Orobico

02



03



04



05

Origin Side Table

Year 2019

T.D. Top Diameter H. Height

Dimensions

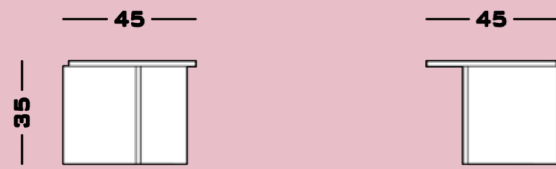

Cod. ORIGIN

T.D. 45

H. 35



We believe that storytelling through design has the power to shape and change our world. We believe in a more creative future.

Sketch Side Table

Sketch Side Table

Year 2020



The Sketch Side table is an homage to the start of any design. Where any line or unusual shape can lead you into a different direction or give you a new solution.

One sketched line is extruded into a metal base and a circular top is attached to it. The base is available in any metal finish or RAL colour. The top is available in metal, wood or marble.

Finishes

Metal

Satin Aluminium
Satin Brass
Satin Bronze
Satin Champagne

Polished Aluminium
Polished Brass
Polished Bronze
Polished Champagne

Blue Cenere
Cenere
Jet Black
Off White

Standard Marble

Arabescato Orobico
Carrara CD
Dark Emperador
Nero Marquina
Travertino Filled
Travertino Open Pore

Premium Marble

Calacatta
Fior Di Pesco
Rosso Levanto
Verde Alpi

Wood Lacquered

Lacquered Matte
Lacquered Glossy

Dimensions

58 W x 37 D x 31.5 H
58 W x 37 D x 33 H
58 W x 37 D x 33 H



Metal. Polished Aluminium

Wood Lacquered. Azure Blu Glossy

01



Marble. Carrara CD

Metal. Polished Aluminium

02

03



04



Sketch Side Table

Year 2020

W. Width D. Depth H. Height

Dimensions

— 37 —

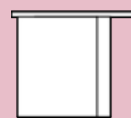

— 31,5 —



— 50 —

— 28 —

Cod. SKTCMET

W. 58

D. 37

H. 31.5

— 37 —

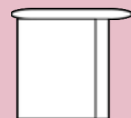

— 33 —



— 50 —

— 28 —

Cod. SKTCLAC

W. 58

D. 37

H. 33

— 37 —

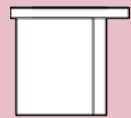

— 33 —



— 50 —

— 28 —

Cod. SKTCMAR

W. 58

D. 37

H. 33



We believe that storytelling through design has the power to shape and change our world. We believe in a more creative future.

Orion Side Table

Orion Side Table

The 3 kings of Orion's belt: offering 3 different heights and sizes of brushed metal disc, the combination of which provides a practical and sculptural side table.

Year 2019



Orion is available in a number of metal finishes including satin and polished options.

Finishes

Metal

Satin Aluminium
Satin Brass
Satin Bronze
Satin Champagne

Polished Aluminium
Polished Brass
Polished Bronze
Polished Champagne

Blue Cenere
Cenere
Jet Black
Off White

Dimensions

1: 20 Dia x 30 H
2: 15 Dia x 50 H
3: 20 Dia x 70 H



Metal. Satin Brass

01



Metal. Satin Brass

02



03



04



05

Orion Side Table

Year **2019** Dimensions

D.1. Diameter 1 **D.2.** Diameter 2 **D.3.** Diameter 3 **H.1.** Height 1 **H.2.** Height 2 **H.3.** Height 3

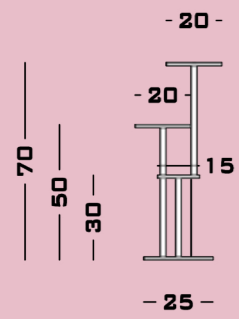

Cod. ORION

D.1.	15
D.2.	20
D.3.	20
H.1.	30
H.2.	50
H.3.	70

189.Taoto Dining Chair / **193.**Giardino Botanico Collection / **197.**Masa Dining Chair /
201.Richmond Dining Chair / **205.**Richmond Barstool / **209.**Nuba Pouf / **213.**Nuba Bench /
217.Nara Stool / **221.**Douglas Pouf / **225.**Ollie Pouf / **229.**Inge Chair / **233.**Inge Pouf /
237.Luna Chair

Seating



We believe that storytelling through design has the power to shape and change our world. We believe in a more creative future.

Taoto Dining Chair

Taoto Dining Chair

Year 2024



TAOTO Dining Chair takes influence from a myriad of places, past and future, so many so that the end result is something completely unrecognisable, a perfect mélange of past experiences and cultures that come together to create something unseen and unique.

TAOTO is harmonised by several beautiful details that make this collection of shapes into one surprising yet functional form. Available in an upholstered and a lacquered version, TAOTO has a number of customisation options.

Finishes

Wood Lacquered

Lacquered Matte
Lacquered Glossy

Wood

Dark Stained Walnut
Grey Stained Walnut
Natural Walnut
White Oak

Upholstery Standard Collection

Cocò
Cotton
Velvet

Upholstery Premium Collection

Nativo
Panama
Bouclé Mélange
Soft Bouclé
Suede

Upholstery Special Collection

Leather
Nabuk
Bouclé

Dimensions

45 W x 52 D x 82 H seat H. 46



Wood Lacquered. Tortora Glossy

Upholstery. Soul White Leather

01



Wood Lacquered. Tortora Glossy

Upholstery. Soul White Leather

02

03



04



Taoto Dining Chair

Year 2024

W. Width D. Depth S.H. Seat Height B.H. Backrest Height

Dimensions

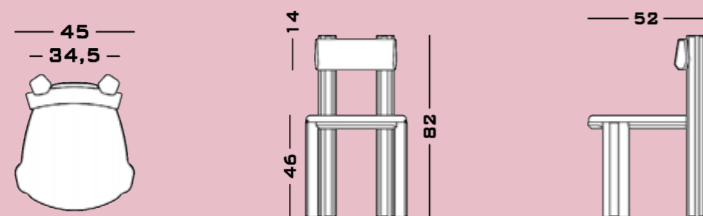

Cod. TAOTO

W.	45
D.	52
S.H.	46
B.H.	82



We believe that storytelling through design has the power to shape and change our world. We believe in a more creative future.

Giardino Botanico Collection

Giardino Botanico Collection

Year 2018



The 'Giardino Botanico' collection features five pouffes, each with a backrest inspired by a distinctive botanic shape. The backrest has some flexibility for added comfort and is gently curved to cradle the user.

The 'Giardino Botanico' collection is available in a number of metal finishes and also comes in stained, solid wood.

Finishes

Metal

Satin Aluminium
Satin Brass
Satin Bronze
Satin Champagne

Polished Aluminium
Polished Brass
Polished Bronze
Polished Champagne

Blue Cenere
Cenere
Jet Black
Off White

Wood

Dark Stained Walnut
Grey Stained Walnut
Natural Walnut
White Oak

Upholstery Standard Collection

Cocò
Cotton
Velvet

Upholstery Premium Collection

Nativo
Panama
Bouclé Mélange
Soft Bouclé
Suede

Upholstery Special Collection

Leather
Nabuk
Bouclé

Dimensions

43.5 Dia x 42 seat H. Back H 95



Holly Pouf

01



Ivy Pouf

02



Jasmine Pouf

03



Lily Pouf

04



Daisy Pouf

05



06



07



08

Giardino Botanico Collection / Metal Year 2018

S.D. Seat Diameter S.H. Seat Height B.H. Backrest Height

Dimensions

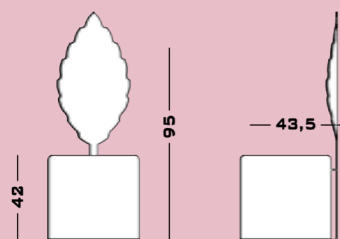

Cod. GBHOLLY

S.D. 43,5
S.H. 42
B.H. 95

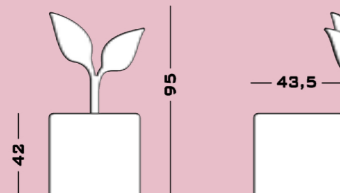

Cod. GBIVY

S.D. 43,5
S.H. 42
B.H. 95

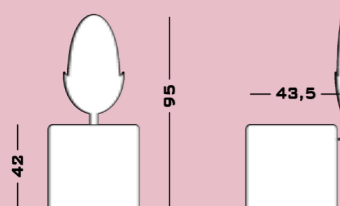

Cod. GBJAS

S.D. 43,5
S.H. 42
B.H. 95

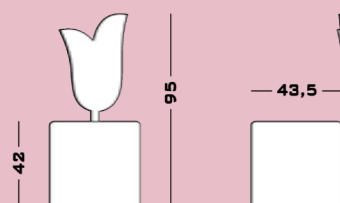

Cod. GBLILY

S.D. 43,5
S.H. 42
B.H. 95

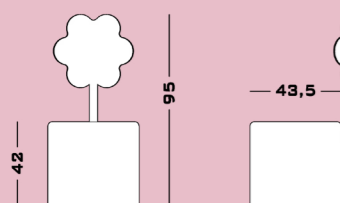

Cod. GBDAISY

S.D. 43,5
S.H. 42
B.H. 95

Giardino Botanico Collection / Wood Year 2018

S.D. Seat Diameter S.H. Seat Height B.H. Backrest Height

Dimensions

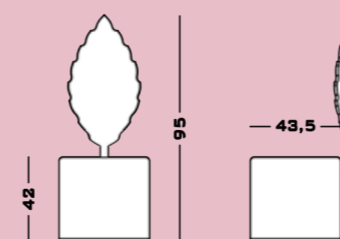

Cod. GBWHOLLY

S.D. 43,5
S.H. 42
B.H. 95

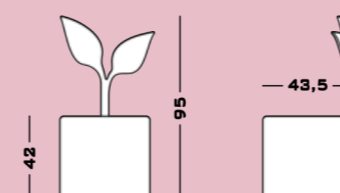

Cod. GBWIVY

S.D. 43,5
S.H. 42
B.H. 95

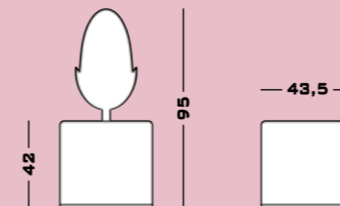

Cod. GBWJAS

S.D. 43,5
S.H. 42
B.H. 95

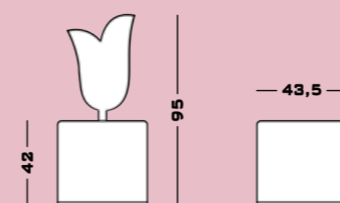

Cod. GBWLILY

S.D. 43,5
S.H. 42
B.H. 95

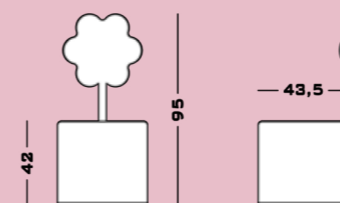

Cod. GBWDAISY

S.D. 43,5
S.H. 42
B.H. 95

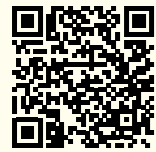

We believe that storytelling through design has the power to shape and change our world. We believe in a more creative future.

Masa Dining Chair

Masa Dining Chair

Year 2024



A familiar friend; reassuring and inviting - A testament to today's advancements in production capabilities, the MASA chair stands as a characterful dining chair with a playful profile.

Constructed from curved wood and coated in a heavy lacquer and upholstered in a variety of fabrics, MASA's soft, almost inflated shapes give it a somewhat transient allure.

Finishes

Wood Lacquered

Lacquered Matte
Lacquered Glossy

Wood

Dark Stained Walnut
Grey Stained Walnut
Natural Walnut
White Oak

Upholstery Standard Collection

Cocò
Cotton
Velvet

Upholstery Premium Collection

Nativo
Panama
Bouclé Mélange
Soft Bouclé
Suede

Upholstery Special Collection

Leather
Nabuk
Bouclé

Dimensions

57 W x 57 D x 96,3 H seat H. 46,7



Wood Lacquered. Tortora Glossy

Upholstery. Soul White Leather

01



Wood Lacquered. Tortora Glossy

Upholstery. Soul White Leather

02

03



Masa Dining Chair

Year 2024

W. Width D. Depth S.H. Seat Height B.H. Backrest Height

Dimensions

Cod. MASA

W.	57
D.	57
S.H.	46,7
B.H.	96,3

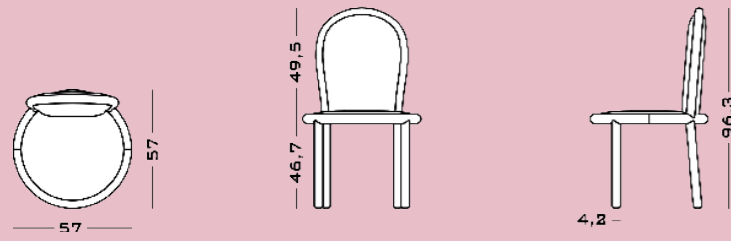



We believe that storytelling through design has the power to shape and change our world. We believe in a more creative future.

Richmond Dining Chair

Richmond Dining Chair

Year 2020



The Richmond dining chair is a dining chair designed for the foodies; the perfect chair for taking your time over a meal and designed to be used for a long time. Both the seat and back are fully upholstered and supported by a wooden frame.

The back is curved to cradle the user. Both the back and seat can be upholstered in any fabric including COM and the wood is available in a number of finishes.

Finishes

Wood

Dark Stained Walnut
Grey Stained Walnut
Natural Walnut
White Oak

Upholstery Standard Collection

Cocò
Cotton
Velvet

Upholstery Premium Collection

Nativo
Panama
Bouclé Mélange
Soft Bouclé
Suede

Upholstery Special Collection

Leather
Nabuk
Bouclé

Dimensions

45 W x 55 D x 46 seat H. Back H 82



Wood. Dark Stained Walnut

Upholstery. Pearl Bush Bouclé

01



Wood. Dark Stained Walnut

Upholstery. Pearl Bush Bouclé

02

03



04



05



Richmond Dining Chair

Year 2020

W. Width D. Depth S.H. Seat Height B.H. Backrest Height

Dimensions

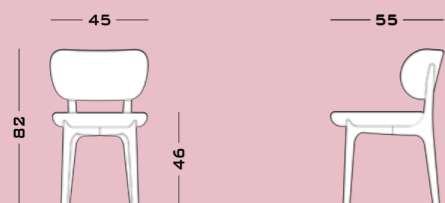

Cod. RICHD

W.	45
D.	55
S.H.	46
B.H.	82



We believe that storytelling through design has the power to shape and change our world. We believe in a more creative future.

Richmond Barstool

Richmond Barstool

Year 2022



Richmond Barstool is an extension of the Richmond family in a literal sense. The Richmond Barstool takes the language of the Richmond dining chair but translates the form into something quite unique. A lower back allows for a less obtrusive piece & integrated footrest allow for additional comfort when being used for a long period of time.

The wooden structure of Richmond Barstool can be finished in any of our wood finishes and the upholstered elements in a wide range of fabrics, suedes and leathers.

Finishes

Wood

Dark Stained Walnut
Grey Stained Walnut
Natural Walnut
White Oak

Upholstery Standard Collection

Cocò
Cotton
Velvet

Upholstery Premium Collection

Nativo
Panama
Bouclé Mélange
Soft Bouclé
Suede

Upholstery Special Collection

Leather
Nabuk
Bouclé

Dimensions

50 W x 55 D x 68 seat H. Back H 88
50 W x 50 D x 68 seat H.



Wood. White Oak

Upholstery. Pearl Bush Bouclé

01



Wood. White Oak

Upholstery. Pearl Bush Bouclé

02



03



04



05

Richmond Barstool

Year **2022**

W. Width **D.** Depth **B.H.** Backrest Height **S.H.** Seat Height

Dimensions

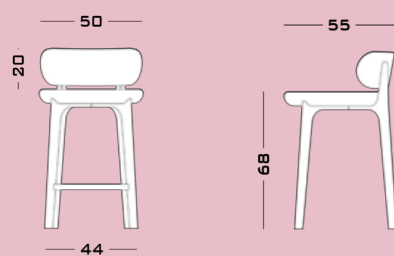

Cod. RICHBB

W.	50
D.	55
S.H.	68
B.H.	88

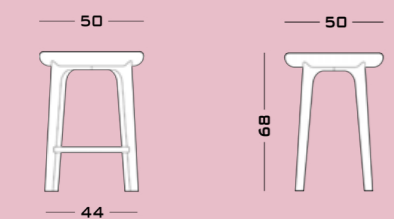

Cod. RICHB

W.	50
D.	50
S.H.	68



We believe that storytelling through design has the power to shape and change our world. We believe in a more creative future.

Nuba Pouf

Nuba Pouf

Year 2024



The Nuba pouf is a sculptural pouf made unique by its continuous, uninterrupted curves. The Nuba series holds a sense of importance that is made clear by the substance and solidity of the pieces.

Soft to the touch and flexible to different environments; Nuba pouf is available in a number of upholstery options. The series is completed by an equally simple yet exciting bench.

Finishes

Upholstery Standard Collection

Cocò
Cotton
Velvet

Upholstery Premium Collection

Nativo
Panama
Bouclé Mélangé
Soft Bouclé

Upholstery Special Collection

Leather
Nabuk
Bouclé

Dimensions

60 Dia x 42 H



Upholstery. Limed Oak Cotton

01



Upholstery. Limed Oak Cotton

02

03



04



Nuba Pouf

Year 2024

W. Width D. Depth H. Height

Dimensions



Cod. NUBAP

W. 60
D. 60
H. 42



We believe that storytelling through design has the power to shape and change our world. We believe in a more creative future.

Nuba Bench

Nuba Bench

Year 2024



The Nuba bench is a sculptural bench made unique by its continuous, uninterrupted curves. The Nuba series holds a sense of importance that is made clear by the substance and solidity of the pieces.

Soft to the touch and flexible to different environments; Nuba bench is available in a number of upholstery options. The series is completed by an equally simple yet impactful pouf.

Finishes

Upholstery Standard Collection

Cocò
Cotton
Velvet

Upholstery Premium Collection

Nativo
Panama
Bouclé Mélange
Soft Bouclé

Upholstery Special Collection

Leather
Nabuk
Bouclé

Dimensions

180 W x 77 D x 42 H



Upholstery. Limed Oak Cotton

01



Upholstery. Limed Oak Cotton

02

03



04



05



Nuba Bench

Year 2024

W. Width D. Depth H. Height

Dimensions

Cod. NUBAB

W. 180

D. 77

H. 42

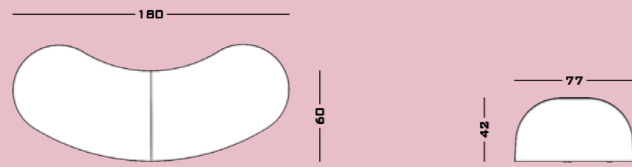



We believe that storytelling through design has the power to shape and change our world. We believe in a more creative future.

Nara Stool

Nara Stool

The Nara stool is a minimal one-seater stool with references to ancient Japanese architecture and forms. Nara is the perfect piece to sit in the corner of a room

Year 2021



until needed, her combination of strong straight lines and soft, curved upholstery give her a grand presence like an ancient temple.

Finishes

Wood

Dark Stained Walnut
Grey Stained Walnut
Natural Walnut
White Oak

Upholstery Standard Collection

Cocò
Cotton
Velvet

Upholstery Premium Collection

Nativo
Panama
Bouclé Mélange
Soft Bouclé
Suede

Upholstery Special Collection

Leather
Nabuk
Bouclé

Dimensions

73.5 W x 40 D x 44 seat H.



Wood. White Oak

Upholstery. Desert Storm Cocò

01



Wood. White Oak

Upholstery. Desert Storm Cocò

02

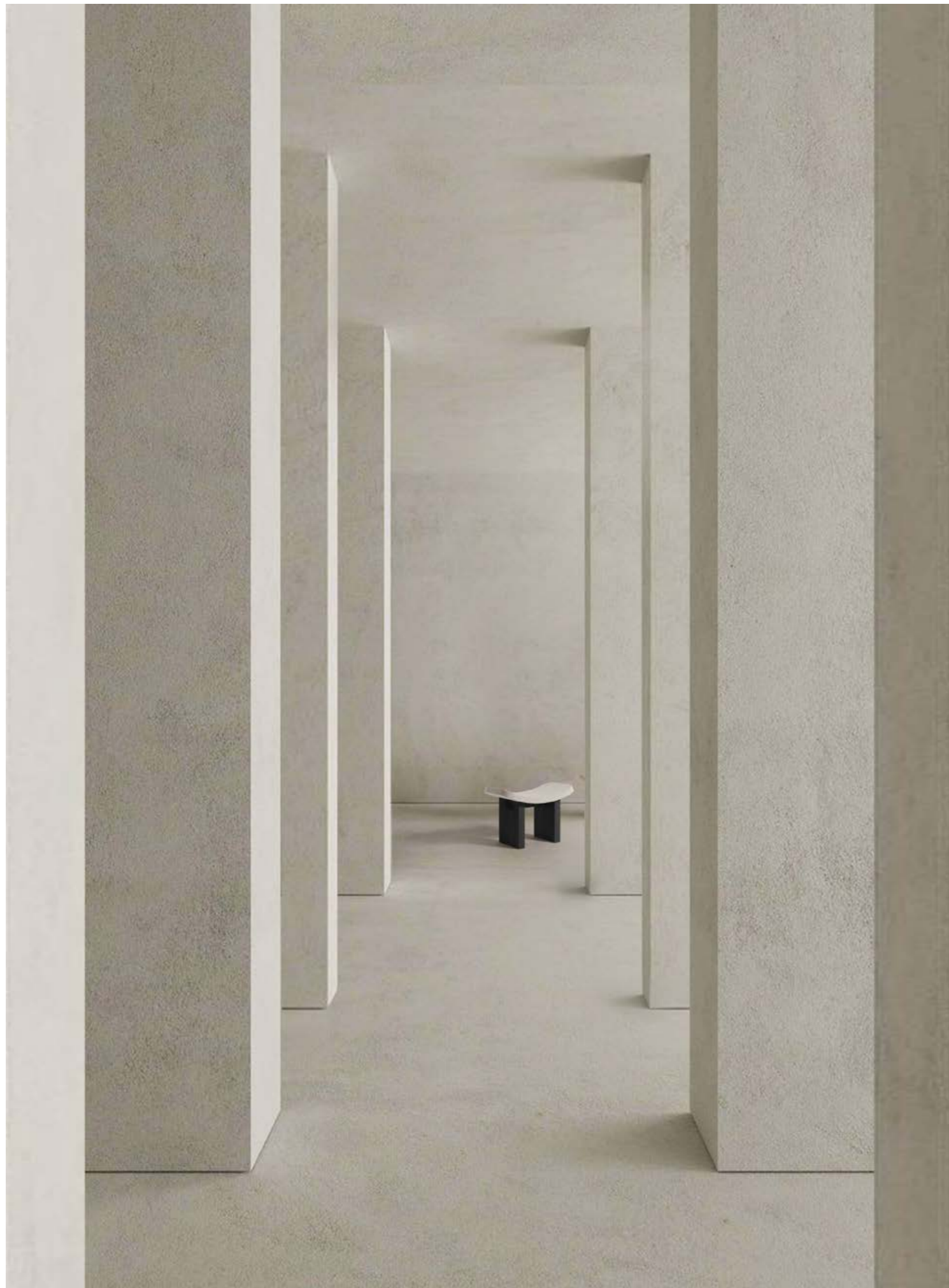

Nara Stool

Year 2021

W. Width D. Depth S.H. Seat Height

Dimensions

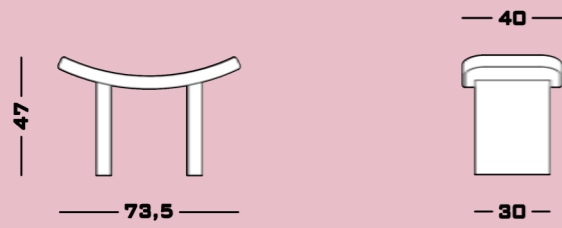

Cod. NARA

W. 73,5

D. 40

S.H. 44



We believe that storytelling through design has the power to shape and change our world. We believe in a more creative future.

Douglas Pouf

Douglas Pouf

Douglas is a characterful stool designed to move around the room and act as a seat or side table for whoever needs it.

Year 2021



Available in a number of upholstery options, Douglas is a must for any space where people gather together.

Finishes

Upholstery Standard Collection

Cocò
Cotton

Upholstery Premium Collection

Nativo
Panama
Bouclé Mélange
Soft Bouclé

Upholstery Special Collection

Leather
Nabuk
Bouclé

Dimensions

40 W x 40 D x 40 seat H.



Upholstery. Bison Hide Bouclé

01

03



04



05



Douglas Pouf

Year 2021

W. Width D. Depth H. Height

Dimensions

Cod. DOUGLAS

W. 40

D. 40

H. 40

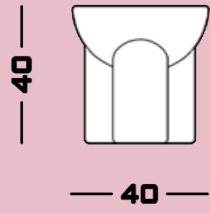



We believe that storytelling through design has the power to shape and change our world. We believe in a more creative future.

Ollie Pouf

Ollie Pouf

Year 2021



Ollie is a playful addition to a living space. Full of character, he offers a generous seat for whoever needs it.

Ollie is designed to move around the room and take up different positions every day. Available in many upholstery options, the perfect Ollie is ready for your space.

Finishes

Upholstery Standard Collection

Cocò
Cotton

Upholstery Premium Collection

Nativo
Panama
Bouclé Mélange
Soft Bouclé

Upholstery Special Collection

Leather
Nabuk
Bouclé

Dimensions

60 W x 60 D x 52 seat H.



Upholstery. Gray Chateau Bouclé

01

03



04



05



Ollie Pouf

Year 2021

W. Width D. Depth H. Height

Dimensions

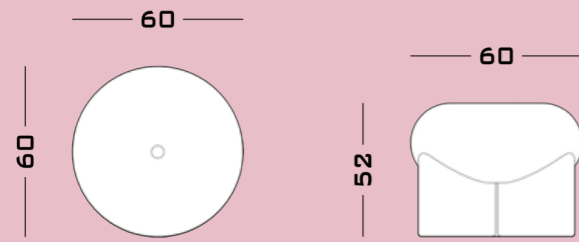

Cod. OLLIE

W. 60
D. 60
H. 52



We believe that storytelling through design has the power to shape and change our world. We believe in a more creative future.

Inge Chair

Inge Chair

Year 2021



The Inge chair is comprised of three identical pieces and a seat. Two of the pieces make up the legs and the third acts as the back creating a contemporary silhouette with many customisation options.

Inge is available with or without the back and in a number of fabrics including COM. Pair two fabrics together to create an exciting two-tone palette.

Finishes

Upholstery Standard Collection

Cocò
Cotton
Velvet

Upholstery Premium Collection

Nativo
Panama
Bouclé Mélangé
Soft Bouclé
Suede

Upholstery Special Collection

Leather
Nabuk
Bouclé

Dimensions

70 W x 50 D x 45 seat H. Back H 78



Upholstery. Soul White Leather

01



Upholstery. Soul White Leather

02

02



03



04



Inge Chair

Year 2021

W. Width D. Depth S.H. Seat Height B.H. Backrest Height

Dimensions

Cod. INGC

W. 70
D. 50
S.H. 45
B.H. 78

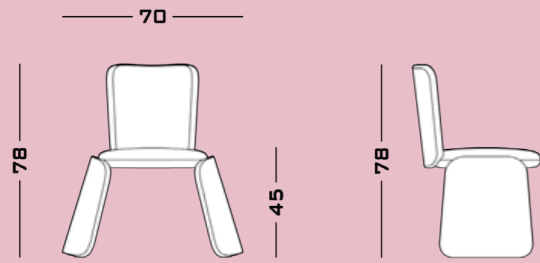



We believe that storytelling through design has the power to shape and change our world. We believe in a more creative future.

Inge Pouf

Inge Pouf

The Inge Pouf is comprised of two identical pieces and a seat that coming together to create a unique formation.

Year 2021



Inge is available with or without the back and in a number of fabrics including COM. Pair two fabrics together to create an exciting two-tone palette.

Finishes

Upholstery Standard Collection

Cocò
Cotton
Velvet

Upholstery Premium Collection

Nativo
Panama
Bouclé Mélangé
Soft Bouclé
Suede

Upholstery Special Collection

Leather
Nabuk
Bouclé

Dimensions

70 W x 43 D x 45 seat H.



Upholstery. Soul White Leather

01



Upholstery. Soul White Leather

02

03



Inge Pouf

Year 2021

W. Width D. Depth S.H. Seat Height

Dimensions

Cod. INGP

W. 70

D. 43

S.H. 45

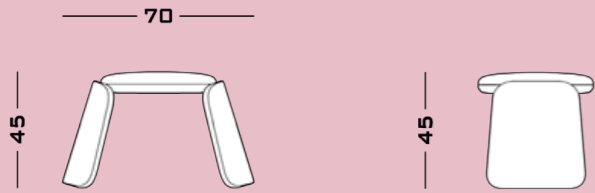



We believe that storytelling through design has the power to shape and change our world. We believe in a more creative future.

Luna Chair

Luna Chair

A hand-crafted wooden dining chair inspired by vintage forms and contemporary techniques. Two almost-circles acting as the backrest and seat offering comfort and style.

Year 2019



The structure holding the chair is in a contrasting wood and is designed with parallel lines and right angles. Luna is characterised by the contrast between straight lines and curves.

Finishes

Wood

Dark Stained Walnut
Grey Stained Walnut
Natural Walnut
White Oak

Dimensions

45 W x 50 D x 46 seat H. Back H 78



Wood. Natural Walnut

Wood. Dark Stained Walnut

01



Wood. Natural Walnut

Wood. Dark Stained Walnut

02

03



04

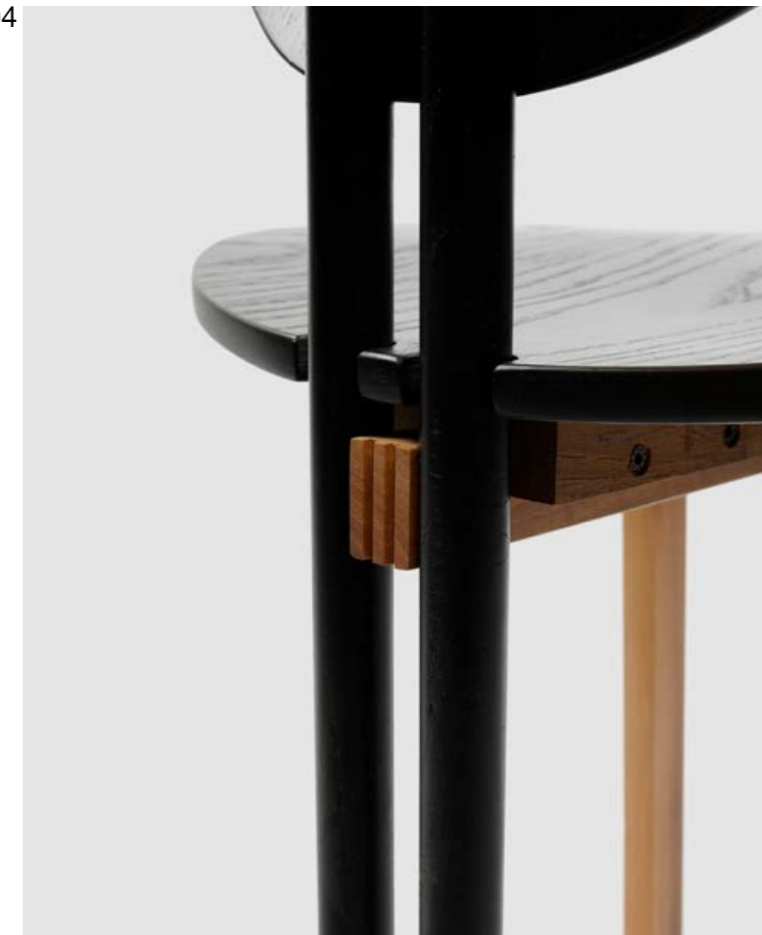

05



Luna Chair

Year 2019

W. Width D. Depth S.H. Seat Height B.H. Backrest Height

Dimensions

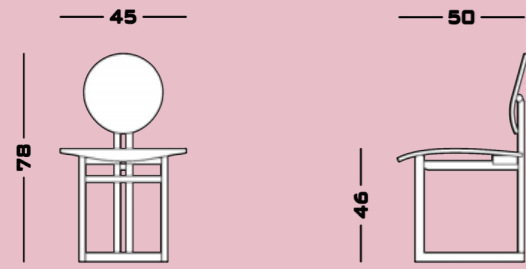

Cod. LUNA

W.	45
D.	50
S.H.	46
B.H.	78

**242.Laghi I Dining Table / 246.Laghi II Dining Table / 250.Inge Dining Table /
254.Inge Marble Dining Table / 258.Silo Dining Table / 262.Monith Dining Table /
266.Horus Dining Table / 270.Horus Marble Dining Table**

Dining Tables



We believe that storytelling through design has the power to shape and change our world. We believe in a more creative future.

Laghi | Dining Table

Laghi I Dining Table

The Laghi dining table is the successor to the Laghi coffee tables. Leaving straight lines and regularity behind, the Laghi dining table is a dramatic yet unobtrusive dining table. Finished in a monochromatic lacquer available in both matte and high gloss

Year 2022



versions, the Laghi dining table is characterised by its soft, flowing curves. A single central base emphasises the dramatic and unique shape of the top. Softened corners give the whole piece a tactile and inviting feel. Available in any RAL colour.

Finishes

Wood Lacquered

Lacquered Matte
Lacquered Glossy

Dimensions

190 W x 150 D x 74 H
210 W x 150 D x 74 H
230 W x 150 D x 74 H



Wood Lacquered. Tortora Matte

01



Wood Lacquered. Tortora Glossy

02

03



04



05



Laghi I Dining Table

Year 2022

W. Width D. Depth H. Height

Dimensions

Cod. LAGHID190

W. 190
D. 150
H. 74

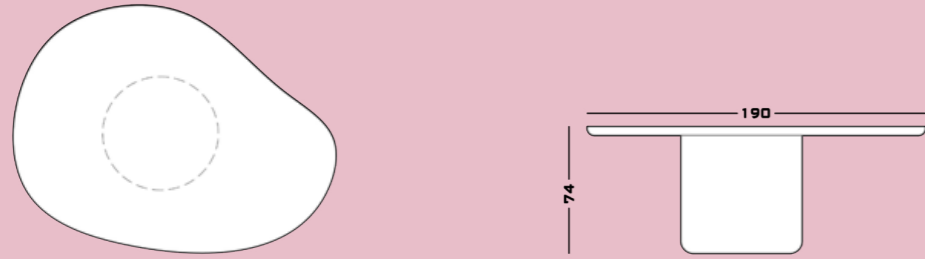

Cod. LAGHID210

W. 210
D. 150
H. 74

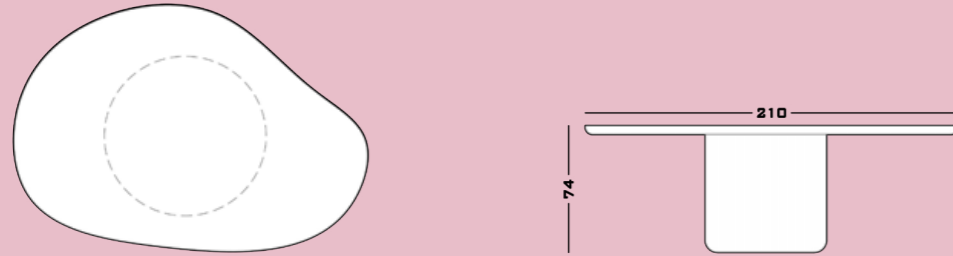

Cod. LAGHID230

W. 230
D. 150
H. 74

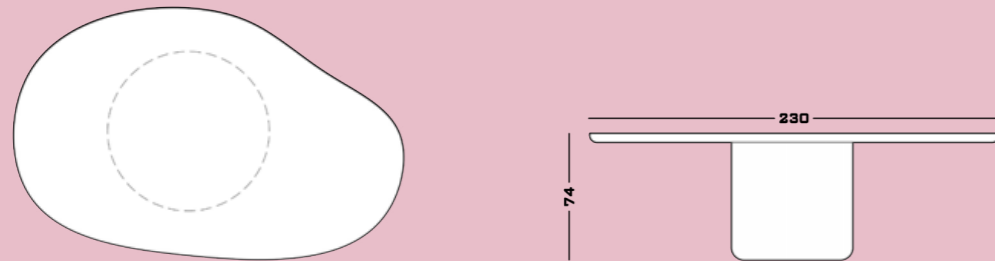



We believe that storytelling through design has the power to shape and change our world. We believe in a more creative future.

Laghi II Dining Table

Laghi II Dining Table

The Laghi dining table is the successor to the Laghi coffee tables. Leaving straight lines and regularity behind, the Laghi dining table is a dramatic yet unobtrusive dining table. Finished in a monochromatic lacquer available in both matte and high gloss

Year 2022



versions, the Laghi dining table is characterised by its soft, flowing curves. Two central bases emphasise the dramatic and unique shape of the top. Softened corners give the whole piece a tactile and inviting feel. Available in any RAL colour.

Finishes

Wood Lacquered

Lacquered Matte
Lacquered Glossy

Dimensions

250 W x 150 D x 74 H
270 W x 150 D x 74 H
290 W x 150 D x 74 H



Wood Lacquered. Nude Glossy

01



Wood Lacquered. Nude Glossy

02

03



04



05



Laghi II Dining Table

Year 2022

W. Width D. Depth H. Height

Dimensions

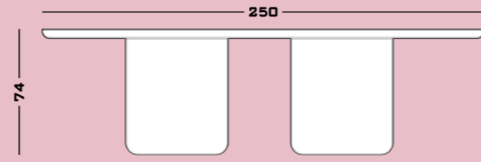
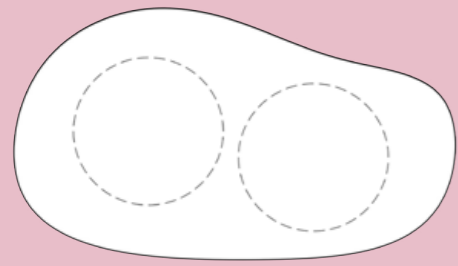

Cod. LAGHID250

W. 250
D. 150
H. 74

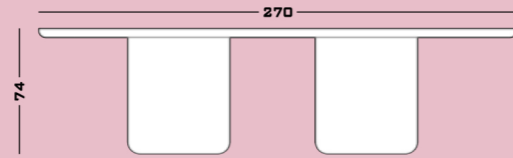
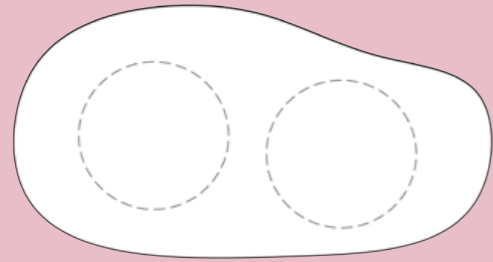

Cod. LAGHID270

W. 270
D. 150
H. 74

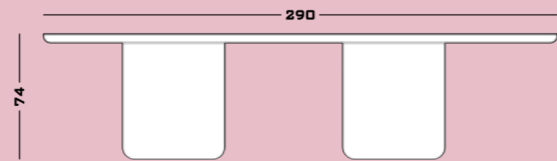
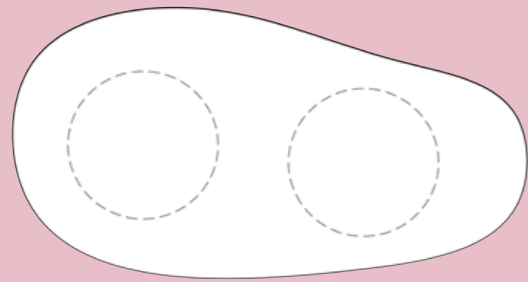

Cod. LAGHID290

W. 290
D. 150
H. 74



We believe that storytelling through design has the power to shape and change our world. We believe in a more creative future.

Inge Dining Table

Inge Dining Table

The Inge table features a striking top, supported by two large stone-like plinths. A beautifully detailed bar spans the distance between them and holds the two together.

Year 2019



Inge takes its name from a famous rock formation in England but is heavily inspired by Japanese architecture. Available in a variety of customisation options.

Finishes

Metal

Satin Aluminium
Satin Brass
Satin Bronze
Satin Champagne

Polished Aluminium
Polished Brass
Polished Bronze
Polished Champagne

Blue Cenere
Cenere
Jet Black
Off White

Wood

Lacquered

Lacquered Matte
Lacquered Glossy

Dimensions

180 W x 110 D x 74 H
210 W x 120 D x 74 H
240 W x 130 D x 74 H



Wood Lacquered. Velvet Green Matte

Metal. Satin Aluminium

01



Wood Lacquered. Steel Blue Matte

Metal. Satin Aluminium

02

03



04



Inge Dining Table

Year 2019

W. Width D. Depth H. Height

Dimensions

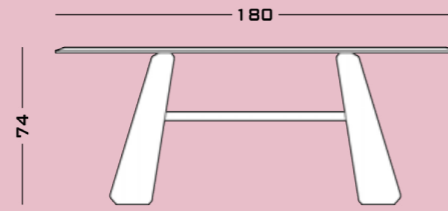

Cod. INGD180

W. 180

D. 110

H. 74

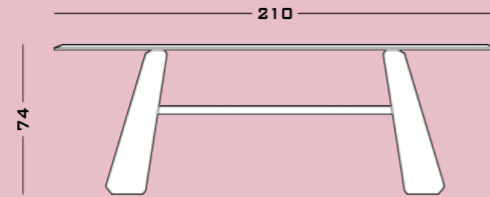

Cod. INGD210

W. 210

D. 120

H. 74

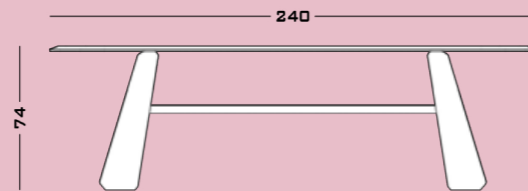

Cod. INGD240

W. 240

D. 130

H. 74



We believe that storytelling through design has the power to shape and change our world. We believe in a more creative future.

Inge Marble Dining Table

Inge Marble Dining Table

Year 2019



The Inge table features a stunning marble top, supported by two large stone-like plinths. A beautifully detailed bar spans the distance between them and holds the two together.

Inge takes its name from a famous rock formation in England but is heavily inspired by Japanese architecture. Available in a variety of customisation options.

Finishes

Metal

Satin Aluminium
Satin Brass
Satin Bronze
Satin Champagne

Polished Aluminium
Polished Brass
Polished Bronze
Polished Champagne

Blue Cenere
Cenere
Jet Black
Off White

Wood Lacquered

Lacquered Matte
Lacquered Glossy

Standard Marble

Arabescato Orobico
Carrara CD
Dark Emperador
Nero Marquina
Travertino Filled
Travertino Open Pore

Premium Marble

Calacatta
Fior Di Pesco
Rosso Levanto
Verde Alpi

Dimensions

180 W x 110 D x 74 H
210 W x 120 D x 74 H
240 W x 130 D x 74 H



Wood Lacquered. Pearl Orange Glossy

Marble. Calacatta

01



Marble. Calacatta

02

03



04



05



Inge Marble Dining Table

Year 2019

W. Width D. Depth H. Height

Dimensions

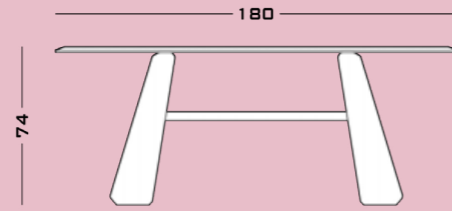

Cod. **INGMD180**

W. 180
D. 110
H. 74

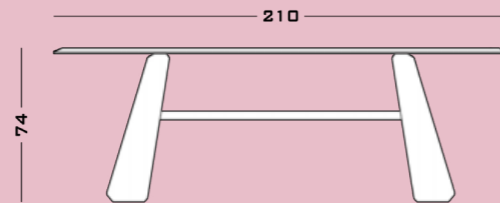

Cod. **INGMD210**

W. 210
D. 120
H. 74

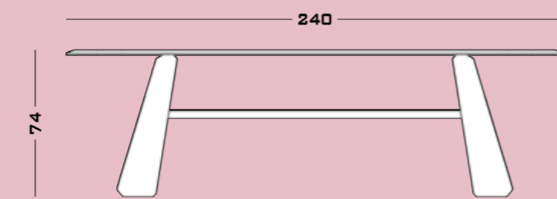
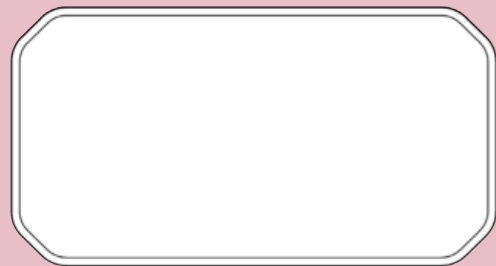

Cod. **INGMD240**

W. 240
D. 130
H. 74



We believe that storytelling through design has the power to shape and change our world. We believe in a more creative future.

Silo Dining Table

Silo Dining Table

Silo Dining Table is an impactful piece designed to explore the usual characteristics of a dining table. For the Silo Dining Table the base and top communicate and coincide harmoniously, both working together to create a piece that is as visually striking as it is minimal and pure.

Year 2023



The size and seeming weight of the top piece gives the entire table a sculptural feel. Each part of Silo can be customised in both matte and high gloss colour options and Silo is available in 3 distinct sizes.

Finishes

Wood Lacquered

Lacquered Matte
Lacquered Glossy

Dimensions

135 Dia x 72 H
155 Dia x 72 H
175 Dia x 72 H



Wood Lacquered. Moor Oak Glossy

01



Wood Lacquered. Moor Oak Glossy

02

03



04



Silo Dining Table

Year 2023

T.D. Top Diameter B.D. Base Diameter H. Height B.H. Base Height

Dimensions

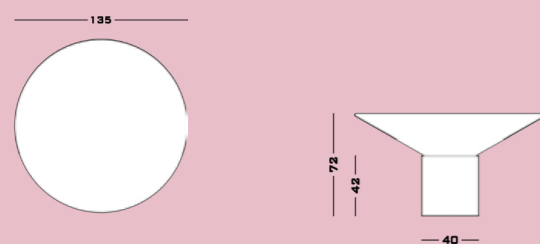

Cod. SILO135

T.D. 135

B.D. 40

H. 72

B.H. 42

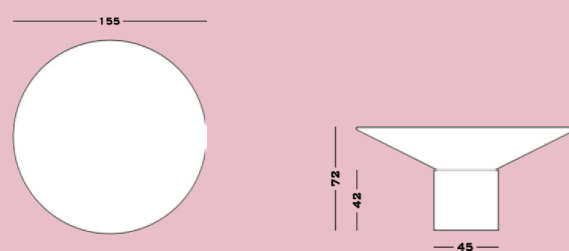

Cod. SILO155

T.D. 155

B.D. 45

H. 72

B.H. 42

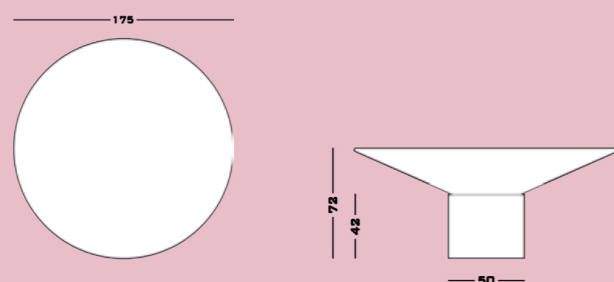

Cod. SILO175

T.D. 175

B.D. 50

H. 72

B.H. 42



We believe that storytelling through design has the power to shape and change our world. We believe in a more creative future.

Monith Dining Table

Monith Dining Table

Year 2024



MONITH is a proud dining table, unafraid to take center-stage. With imperfect top and asymmetrical legs, MONITH is intriguing to the eye, acting not only as a functional object but as something to be observed and understood.

MONITHS imperfections do not make it any less functional, instead, they imagine a story of prior experiences and new beginnings.

Finishes

Wood Lacquered

Lacquered Matte
Lacquered Glossy

Mirror

Extra-clear Mirror

Dimensions

260 W x 130 D x 72 H
280 W x 130 D x 72 H
300 W x 130 D x 72 H



Wood Lacquered. Blue Cenere Glossy Mirror. Extra-clear mirror

01



Wood Lacquered. Blue Cenere Glossy Mirror. Extra-clear mirror

02

03



04



Monith Dining Table

Year 2024

W. Width D. Depth H. Height

Dimensions

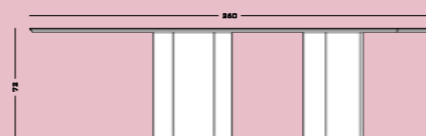

Cod. MON260

W. 260
D. 130
H. 72



Cod. MON280

W. 280
D. 130
H. 72

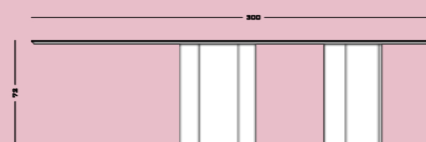

Cod. MON300

W. 300
D. 130
H. 72



We believe that storytelling through design has the power to shape and change our world. We believe in a more creative future.

Horus Dining Table

Horus Dining Table

The Horus table is designed as a play on solid and empty space, providing a light yet striking appearance. The cylindrical base can fit within the metal frame or slightly away to emphasise the contrast between the two elements.

Year 2021



The top and cylindrical leg can be lacquered in any RAL colour and the wireframe portion of the base can be in a number of metal finishes or colours.

Finishes

Metal

Satin Aluminium
Satin Brass
Satin Bronze
Satin Champagne

Polished Aluminium
Polished Brass
Polished Bronze
Polished Champagne

Blue Cenere
Cenere
Jet Black
Off White

Wood

Lacquered

Lacquered Matte
Lacquered Glossy

Dimensions

180 W x 100 D x 73 H
200 W x 110 D x 73 H
220 W x 110 D x 73 H
240 W x 120 D x 73 H
260 W x 120 D x 73 H



Wood Lacquered. Azure Blu Glossy

Metal. Satin Brass

01



Wood Lacquered. Azure Blu Glossy

Metal. Satin Brass

02



03



04



05

Horus Dining Table

Year 2021

W. Width D. Depth H. Height

Dimensions

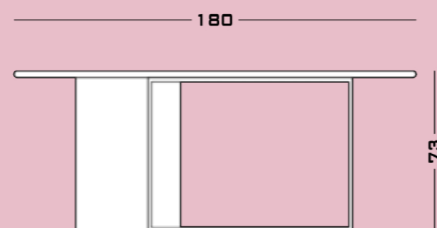
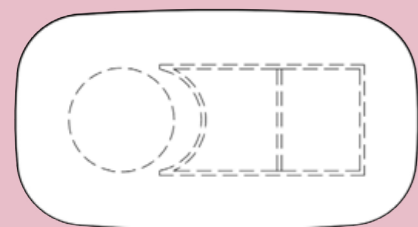

Cod. HRSD180

W. 180
D. 100
H. 73

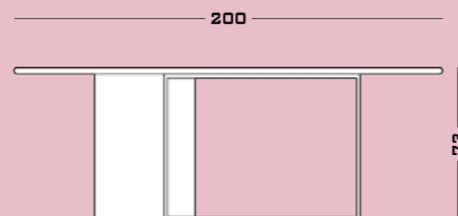
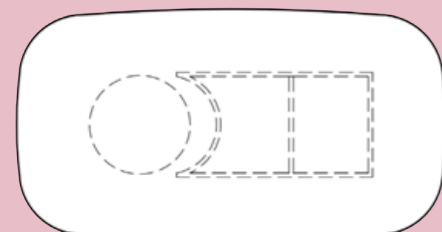

Cod. HRSD200

W. 200
D. 110
H. 73

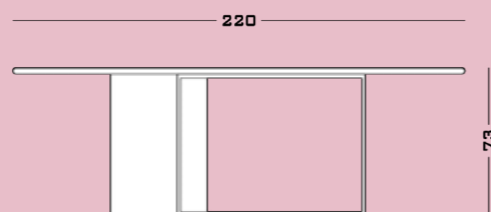
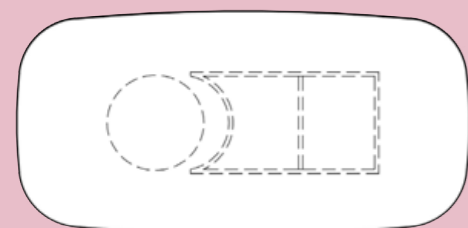

Cod. HRSD220

W. 220
D. 110
H. 73

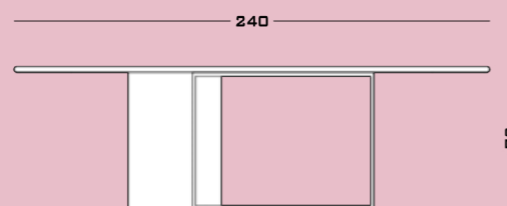
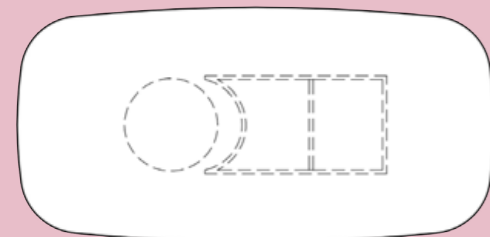

Cod. HRSD240

W. 240
D. 120
H. 73

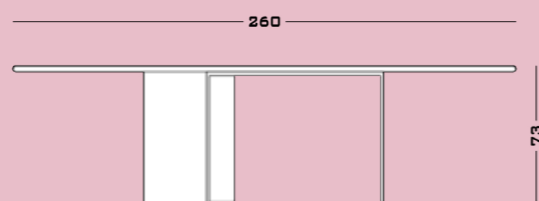
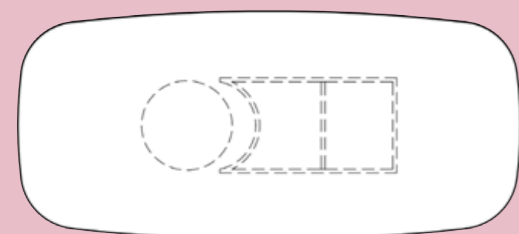

Cod. HRSD260

W. 260
D. 120
H. 73



We believe that storytelling through design has the power to shape and change our world. We believe in a more creative future.

Horus Marble Dining Table

Horus Marble Dining Table

Year 2021



The Horus table is designed as a play on solid and empty space, providing a light yet striking appearance. The cylindrical base can fit within the metal frame or slightly away to emphasise the contrast between the two elements.

The cylindrical leg can be lacquered in any RAL colour and the wireframe portion of the base can be in a number of metal finishes or colours. The top is available in all of our standard and premium marble finishes.

Finishes

Metal

Satin Aluminium
Satin Brass
Satin Bronze
Satin Champagne

Polished Aluminium
Polished Brass
Polished Bronze
Polished Champagne

Blue Cenere
Cenere
Jet Black
Off White

Wood Lacquered

Lacquered Matte
Lacquered Glossy

Standard Marble

Arabescato Orobico
Carrara CD
Dark Emperador
Nero Marquina
Travertino Filled
Travertino Open Pore

Premium Marble

Calacatta
Fior Di Pesco
Rosso Levanto
Verde Alpi

Dimensions

180 W x 100 D x 73 H
200 W x 110 D x 73 H
220 W x 110 D x 73 H
240 W x 120 D x 73 H
260 W x 120 D x 73 H



Marble. Arabescato Orobico

Wood Lacquered. Cenere Glossy

01



Marble. Arabescato Orobico

Metal. Jet Black

02



Horus Marble Dining Table

Year 2021

W. Width D. Depth H. Height

Dimensions

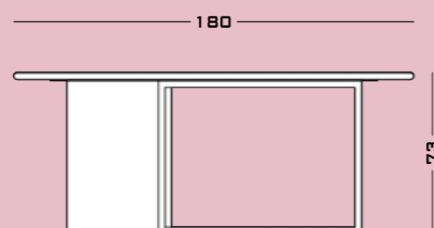
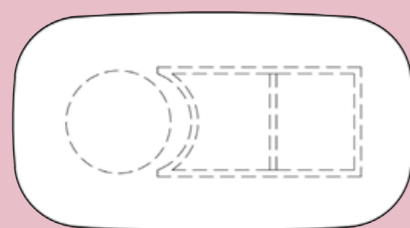

Cod. HRSMD180

W. 180
D. 100
H. 73

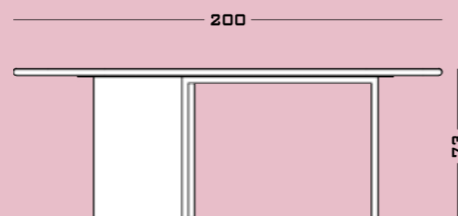
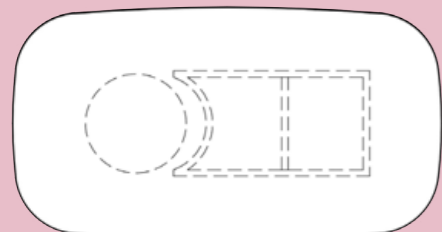

Cod. HRSMD200

W. 200
D. 110
H. 73

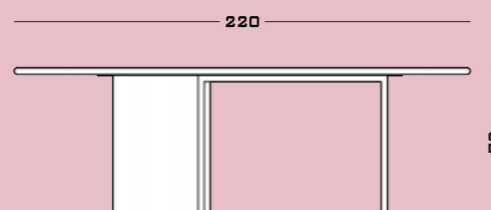
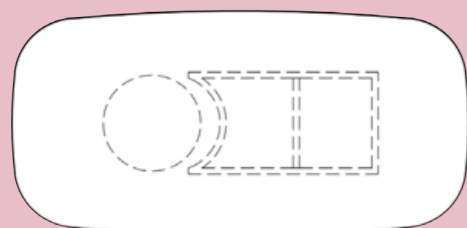

Cod. HRSMD220

W. 220
D. 110
H. 73

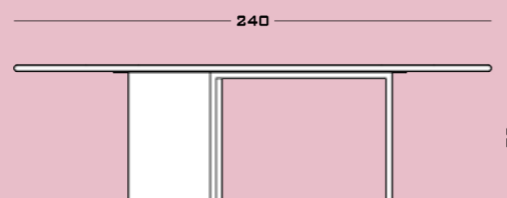
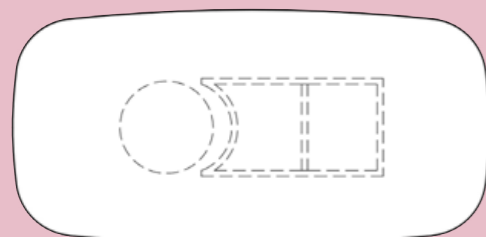

Cod. HRSMD240

W. 240
D. 120
H. 73

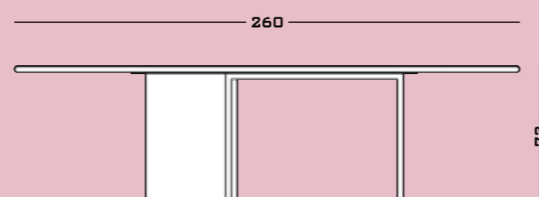
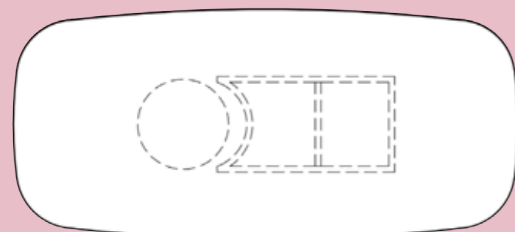

Cod. HRSMD260

W. 260
D. 120
H. 73

275. Lock Console / **279.**Kara Console / **283.**Roll Desk / **287.**Nakamura Desk /
291.Apollo Console / **295.**Apollo Desk

Desks & Consoles



We believe that storytelling through design has the power to shape and change our world. We believe in a more creative future.

Lock Console

Lock Console

Year 2024



LOCK Console is a monolithic object that stands as a single part. By losing the hierarchy between top and legs and allowing the would-be pieces to unify across common angles, three parts become one sculptural, yet minimalist console.

Monochromatic and pure, LOCK Console is available in both high gloss and matte finishes.

Finishes

Wood Lacquered

- Lacquered Matte
- Lacquered Glossy

Dimensions

120 W x 40 D x 80 H



Wood Lacquered. Tortora Glossy

01



Wood Lacquered. Tortora Glossy

02

03



04



Lock Console

Year 2024

W. Width D. Depth H. Height

Dimensions

Cod. LOCKCON

W. 120

D. 40

H. 80

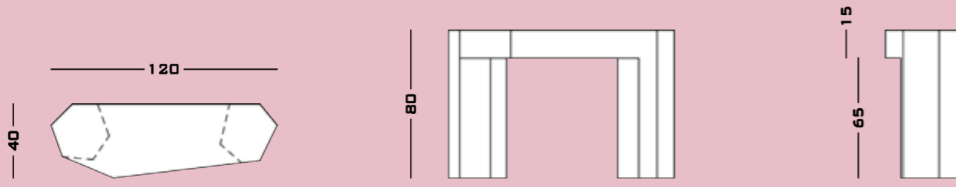



We believe that storytelling through design has the power to shape and change our world. We believe in a more creative future.

Kara Console

Kara Console

Year 2024



KARA is a console centered on the acceptance of imperfection. An alluring, surprising shape of top is not only accepted but embellished and developed by the protruding legs that learn their shape and position from the top. The top and legs of the console are unified and

act as one piece; the combination of which is a console that is unequivocally singular. Kara is available with a mirrored top to highlight the unique shape that it possesses and is available lacquered in both matte and high gloss versions.

Finishes

Wood Lacquered

Lacquered Matte
Lacquered Glossy

Mirror

Extra-clear Mirror

Dimensions

119 W x 29 D x 80,5 H

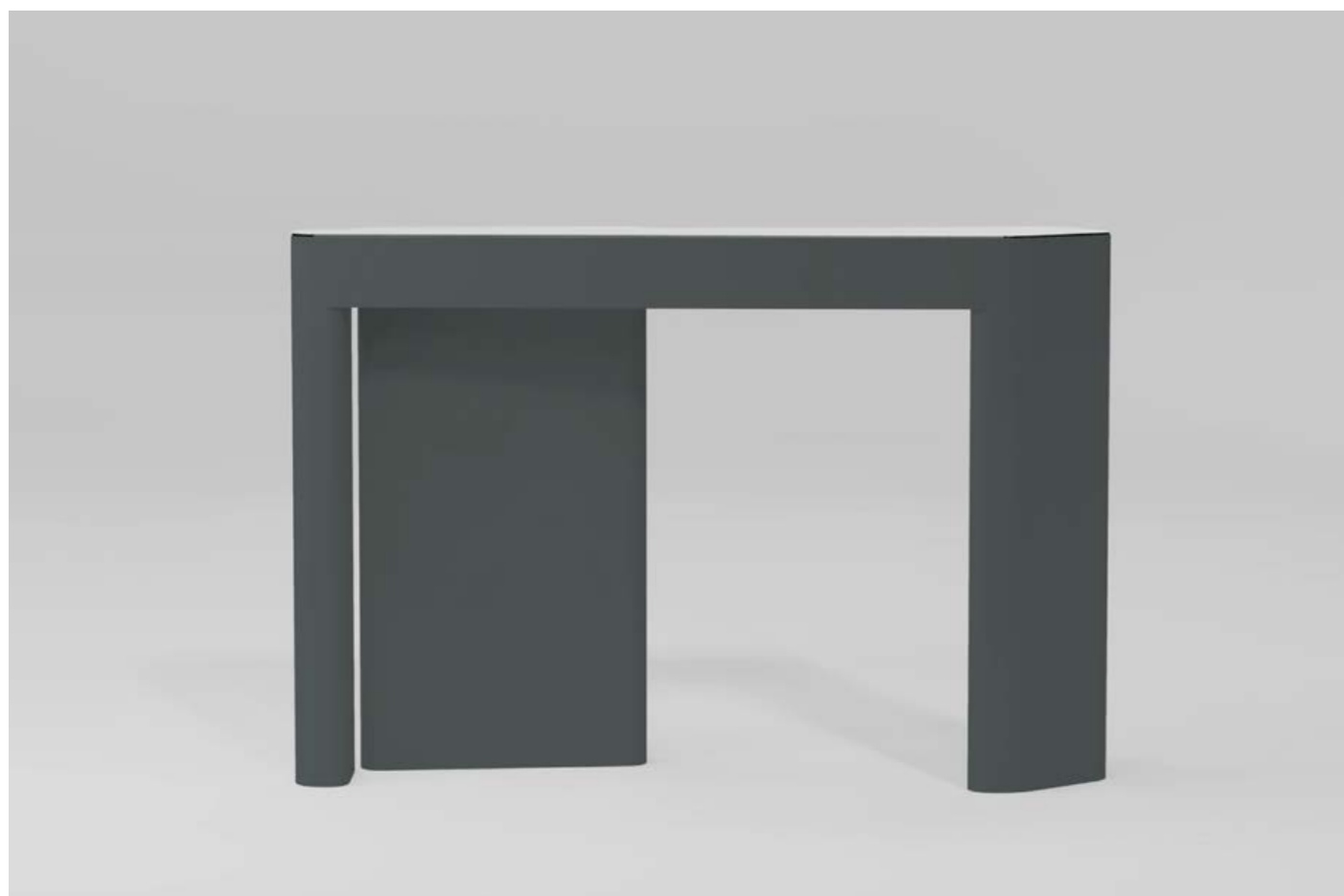

Wood Lacquered. Blue Cenere Glossy Mirror. Extra-clear mirror

01



Wood Lacquered. Blue Cenere Glossy Mirror. Extra-clear mirror

02

03



04



Kara Console

Year 2024

W. Width D. Depth H. Height

Dimensions

Cod. KARA

W. 119
D. 29
H. 80,5

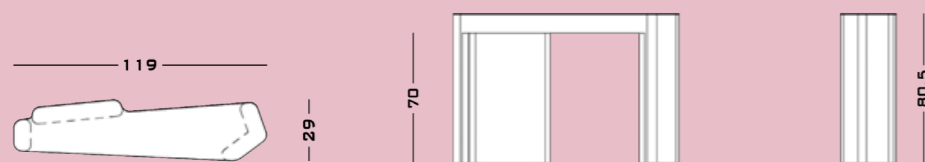



We believe that storytelling through design has the power to shape and change our world. We believe in a more creative future.

Roll Desk

Roll Desk

Year 2019



Writing desk by day and Vanity Table by night; Roll Desk is a minimal piece with four metal legs supporting a solid wooden top. The top is upholstered in suede or leather for easy and comfortable use with the option also for a marble or stone insert.

The back legs are sculpted from one continuous loop, which acts as a rest for a loose, wooden-backed mirror which rolls from side to side. Both drawers are lined with a matching suede or leather base panel. Roll desk is available in different wood and metal finishes.

Finishes

Metal

Satin Aluminium
Satin Brass
Satin Bronze
Satin Champagne

Polished Aluminium
Polished Brass
Polished Bronze
Polished Champagne

Blue Cenere
Cenere
Jet Black
Off White

Wood

Dark Stained Walnut
Grey Stained Walnut
Natural Walnut
White Oak

Standard Marble

Arabescato Orobico
Carrara CD
Dark Emperador
Nero Marquina
Travertino Filled
Travertino Open Pore

Premium Marble

Calacatta
Fior Di Pesco
Rosso Levanto
Verde Alpi

Upholstery Premium Collection

Suede

Upholstery Special Collection

Leather

Mirror

Extra-clear Mirror

Dimensions

104 W x 50 D x 70 H of the top. Tot H 100



Wood. Dark Stained Walnut

Metal. Jet Black

01



Wood. Dark Stained Walnut

Marble. Calacatta

02

03



04



05



Roll Desk

Year 2019

W. Width D. Depth H. Height T.H. Top Height M.D. Mirror Diameter

Dimensions

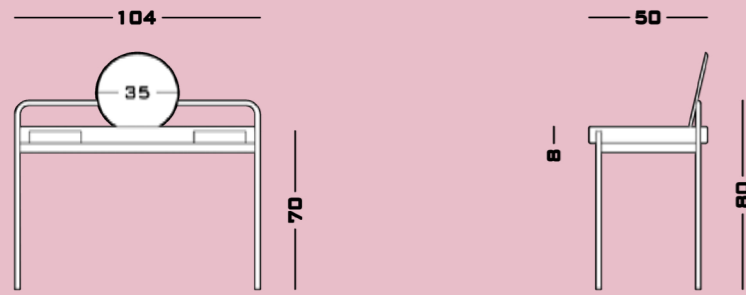

Cod. ROLL

W.	104
D.	50
H.	80
T.H.	70
M.D.	35



We believe that storytelling through design has the power to shape and change our world. We believe in a more creative future.

Nakamura Desk

Nakamura Desk

Year 2021



The Nakamura desk is an exploration of the possibilities and precision of expert leatherworking. Two pieces of leather curve around the table top and meet at only one continuing line.

Available in various leather options and with or without drawers.

Finishes

Metal

Blue Cenere
Cenere
Jet Black
Off White

Upholstery Special Collection

Leather

Wood

Lacquered

Lacquered Matte
Lacquered Glossy

Dimensions

150 W x 67 D x 72 H of the top. Tot H 82



Metal. Jet Black

Upholstery. Soul White Leather

01



Metal. Jet Black

Upholstery. Soul White Leather

02

03



04



05



Nakamura Desk

Year 2021

Dimensions

W. Width D. Depth H. Height T.H. Top Height

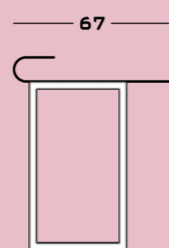
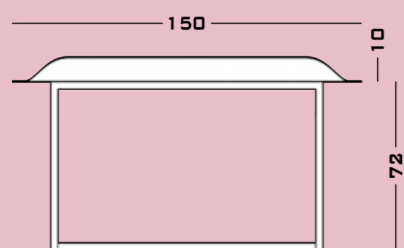

Cod. NAKAND

W. 150
D. 67
H. 82
T.H. 72

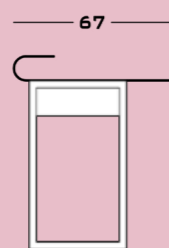
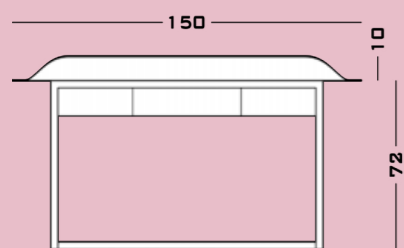

Cod. NAKA

W. 150
D. 67
H. 82
T.H. 72



We believe that storytelling through design has the power to shape and change our world. We believe in a more creative future.

Apollo Console

Apollo Console

Year 2021



Apollo console is a minimal piece which draws inspiration from yin and yang and the balance of everything. The Apollo console consists of a wooden top with inlaid

marble or upholstery. Characterized by its soft curves and round shapes, Apollo is available in a number of different wood, stone and upholstery options.

Finishes

Metal

Blue Cenere
Cenere
Jet Black
Off White

Wood

Dark Stained Walnut
Grey Stained Walnut
Natural Walnut
White Oak

Standard Marble

Arabescato Orobico
Carrara CD
Dark Emperador
Nero Marquina
Travertino Filled
Travertino Open Pore

Premium Marble

Calacatta
Fior Di Pesco
Rosso Levanto
Verde Alpi

Upholstery Premium Collection

Suede

Upholstery Special Collection

Leather

Dimensions

120 W x 40 D x 74 H



Wood. Dark Stained Walnut

Metal. Jet Black

Marble. Calacatta

01



Wood. Dark Stained Walnut

Metal. Jet Black

Marble. Calacatta

02

03



04



05



Apollo Console

Year 2021

W. Width D. Depth H. Height

Dimensions

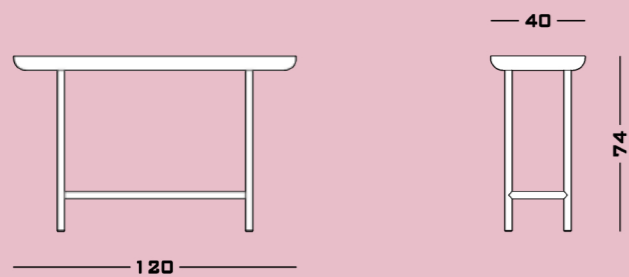

Cod. APOCON

W. 120

D. 40

H. 74



We believe that storytelling through design has the power to shape and change our world. We believe in a more creative future.

Apollo Desk

Apollo Desk

Year 2021



Apollo console is a minimal piece which draws inspiration from yin and yang and the balance of everything. The Apollo Desk consists of a wooden top with marble or upholstered insert.

With two levels and rotating mirror Apollo is the perfect dressing table. Characterized by its soft curves and round shapes, Apollo is available in a number of different wood, stone and upholstery options.

Finishes

Metal

Blue Cenere
Cenere
Jet Black
Off White

Wood

Dark Stained Walnut
Grey Stained Walnut
Natural Walnut
White Oak

Standard Marble

Arabescato Orobico
Carrara CD
Dark Emperador
Nero Marquina
Travertino Filled
Travertino Open Pore

Premium Marble

Calacatta
Fior Di Pesco
Rosso Levanto
Verde Alpi

Upholstery Premium Collection

Suede

Upholstery Special Collection

Leather

Mirror

Extra-clear Mirror

Dimensions

120 W x 40 D x 74 H of the top. Tot H 125



Wood. Dark Stained Walnut

Metal. Jet Black

Marble. Calacatta

01



Wood. Dark Stained Walnut

Metal. Jet Black

Marble. Calacatta

02

03



04



05



Apollo Desk

Year 2021

W. Width D. Depth H. Height T.H. Top Height M.D. Mirror Diameter

Dimensions

Cod. APODES

W.	120
D.	40
H.	125
T.H.	74
M.D.	35

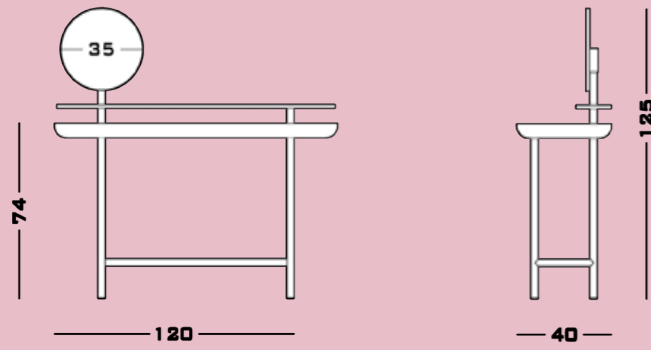

300.Giove Mirror / **304.**Aglaia Mirror / **308.**Laghi Mirrors / **312.**1931 Mirror /
316.Takada Mirror

Mirrors



We believe that storytelling through design has the power to shape and change our world. We believe in a more creative future.

Giove Mirror

Giove Mirror

Year 2019



Giove is a full length mirror supported by a polished marble base with an elegant metal structure. The back of the mirror can be upholstered in a number of different fabrics.

Giove can rotate inside its metal frame, offering comfortable functionality as well as new shapes and angles every time it is moved.

Finishes

Metal

Satin Aluminium
Satin Brass
Satin Bronze
Satin Champagne

Polished Aluminium
Polished Brass
Polished Bronze
Polished Champagne

Blue Cenere
Cenere
Jet Black
Off White

Standard Marble

Arabescato Orobico
Carrara CD
Dark Emperador
Nero Marquina
Travertino Filled
Travertino Open Pore

Premium Marble

Calacatta
Fior Di Pesco
Rosso Levanto
Verde Alpi

Upholstery Standard Collection

Cocò
Cotton
Velvet

Upholstery Premium Collection

Nativo
Panama
Bouclé Mélange
Soft Bouclé
Suede

Upholstery Special Collection

Leather
Nabuk
Bouclé

Mirror

Extra-clear Mirror

Dimensions

54 W x 35 D x 178 H



Metal. Satin Brass

Marble. Calacatta

01



Upholstery. Bone Velvet

Marble. Calacatta

02



03



04



05

Giove Mirror

Year 2019

W. Width D. Depth H. Height

Dimensions

Cod. GIOVE

W. 54
D. 35
H. 178

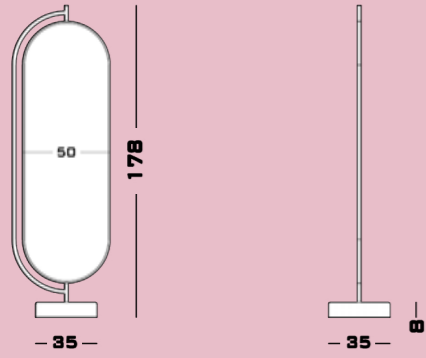



We believe that storytelling through design has the power to shape and change our world. We believe in a more creative future.

Aglaia Mirror

Aglaia Mirror

Year 2020



Aglaia is designed with the simple intention of bringing the beauty of nature into the house. The reverse of the mirror can be upholstered in any fabric or veneer. A seam in the middle allows the pattern to be mirrored across the

middle in the same way a leaf grows simultaneously in two directions. The mirror is framed in brass or any other metal finish and the whole piece is made stable by a solid marble base.

Finishes

Metal

Satin Aluminium
Satin Brass
Satin Bronze
Satin Champagne

Polished Aluminium
Polished Brass
Polished Bronze
Polished Champagne

Blue Cenere
Cenere
Jet Black
Off White

Standard Marble

Arabescato Orobico
Carrara CD
Dark Emperador
Nero Marquina
Travertino Filled
Travertino Open Pore

Premium Marble

Calacatta
Fior Di Pesco
Rosso Levanto
Verde Alpi

Upholstery Standard Collection

Cocò
Cotton
Velvet

Upholstery Premium Collection

Nativo
Panama
Bouclé Mélange
Soft Bouclé
Suede

Upholstery Special Collection

Leather
Nabuk
Bouclé

Wood

Dark Stained Walnut
Grey Stained Walnut
Natural Walnut
White Oak

Mirror

Extra-clear Mirror

Dimensions

60 W x 35 D x 175 H



Metal. Jet Black

Marble. Calacatta

01



Wood. Natural Walnut

Marble. Calacatta

02



03

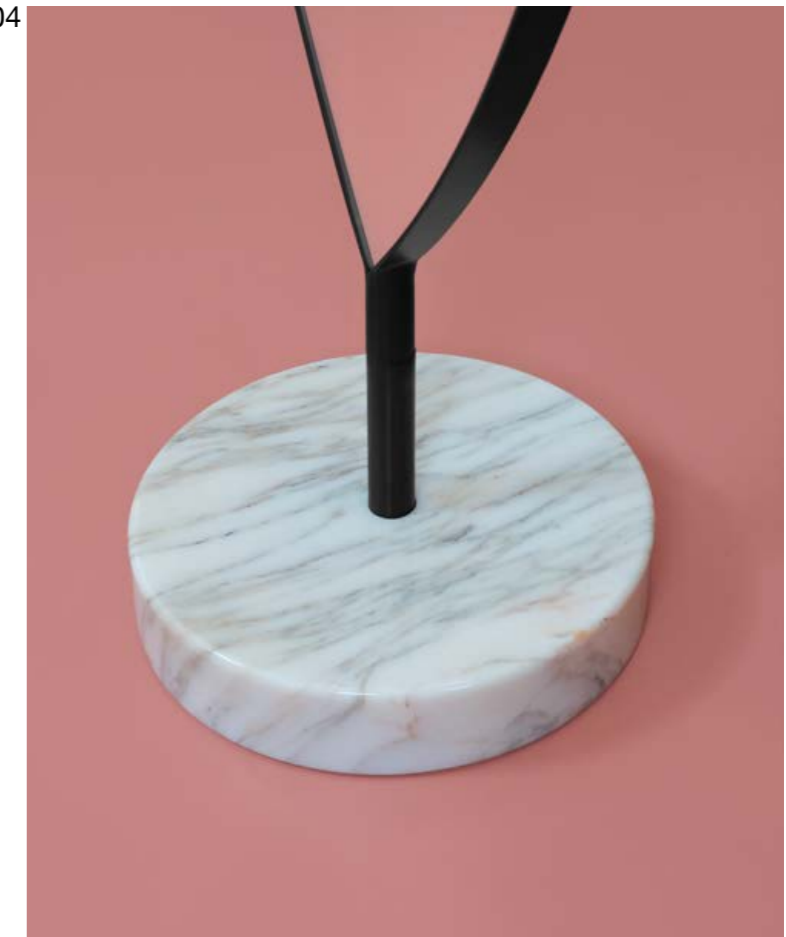

04



05

Aglaia Mirror

Year 2020

W. Width D. Depth H. Height

Dimensions

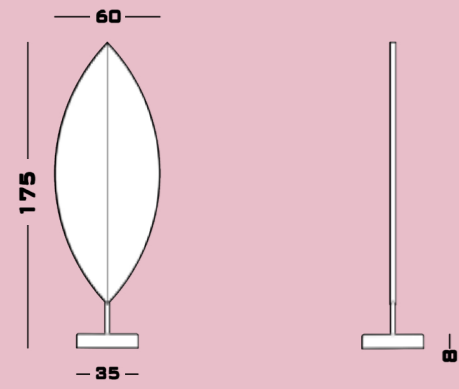

Cod. AGLA

W. 60
D. 35
H. 175



We believe that storytelling through design has the power to shape and change our world. We believe in a more creative future.

Laghi Mirrors

Laghi Mirrors

Laghi mirrors draw inspiration from the various compositions achieved by the Laghi coffee table set. With internal and external curves as well as varying sizes of mirror, each composition can be completely unique.

Year 2022



Laghi mirrors can be finished in any RAL colour with the option for a matte or high gloss finish.

Finishes

Wood Lacquered

Lacquered Matte
Lacquered Glossy

Mirror

Extra-clear Mirror

Dimensions

16 W x 5 D x 25 H
23 W x 5 D x 35 H
30 W x 5 D x 44 H



Wood Lacquered. Off White Matte

01



Wood Lacquered. Off White Matte

02

03



04



Laghi Mirrors

Year **2022**

W. Width D. Depth H. Height

Dimensions



Cod. LAGHIMIRS

W. 16
D. 5
H. 25



Cod. LAGHIMIRM

W. 23
D. 5
H. 35



Cod. LAGHIMIRL

W. 30
D. 5
H. 44



We believe that storytelling through design has the power to shape and change our world. We believe in a more creative future.

1931 Mirror

1931 Mirror

Inspired by the aesthetics and surrealism of Salvador Dali, the 1931 is an amorphous-shaped mirror, seemingly only held in place by a marble sphere.

Year 2021



The mirror is backed in wood which can be lacquered in any RAL colour. Available in a variety of different stones and metal finishes.

Finishes

Standard Marble

Arabescato Orobico
Carrara CD
Dark Emperador
Nero Marquina
Travertino Filled
Travertino Open Pore

Premium Marble

Calacatta
Fior Di Pesco
Rosso Levanto
Verde Alpi

Wood Lacquered

Lacquered Matte
Lacquered Glossy

Mirror

Extra-clear Mirror

Dimensions

63 W x 40 D x 158 H



Mirror. Extra-clear Mirror

Marble. Calacatta

01



Mirror. Extra-clear Mirror

Marble. Calacatta

02

03



04



1931 Mirror

Year 2021

W. Width D. Depth H. Height B.H. Base Height

Dimensions

Cod. 1931

W. 63
D. 40
H. 158
B.H. 12

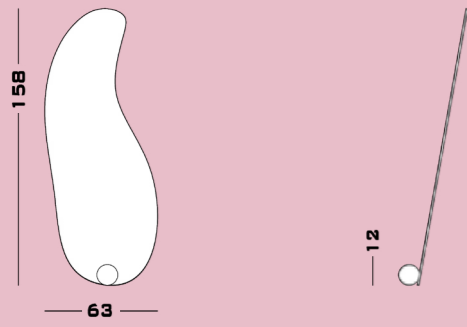



We believe that storytelling through design has the power to shape and change our world. We believe in a more creative future.

Takada Mirror

Takada Mirror

The Takada Mirror is a round top and bottomed mirror, made stable only by its connection to a separate, supporting arch. Both the mirror and arch are wrapped in a metal band which can be brass or any other metal finish.

Year 2020



The back of the mirror and the two sides of the arch can be upholstered in fabric or lacquered in any RAL colour.

Finishes

Metal

Satin Aluminium
Satin Brass
Satin Bronze
Satin Champagne

Polished Aluminium
Polished Brass
Polished Bronze
Polished Champagne

Blue Cenere
Cenere
Jet Black
Off White

Upholstery Standard Collection

Cocò
Cotton
Velvet

Upholstery Premium Collection

Nativo
Panama
Bouclé Mélange
Soft Bouclé
Suede

Upholstery Special Collection

Leather
Nabuk
Bouclé

Wood Lacquered

Lacquered Matte
Lacquered Glossy

Mirror

Extra-clear Mirror

Dimensions

53 W x 60 D x 190 H



Upholstery. Cognac Velvet

Metal. Polished Brass

01



Wood Lacquered. Pearl Orange Glossy Metal. Polished Brass

02

03

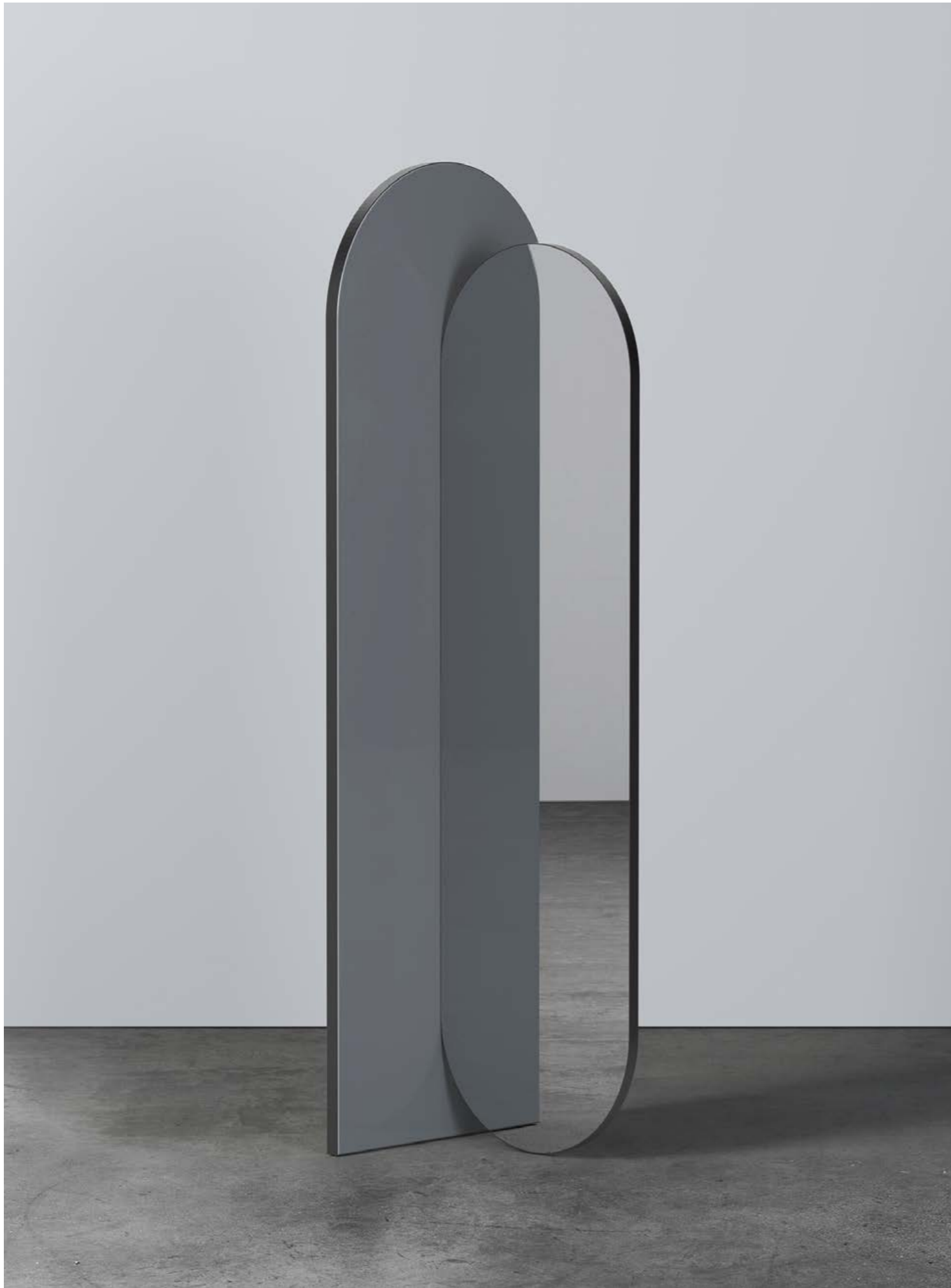

04



Takada Mirror

Year 2020

W. Width D. Depth H. Height

Dimensions

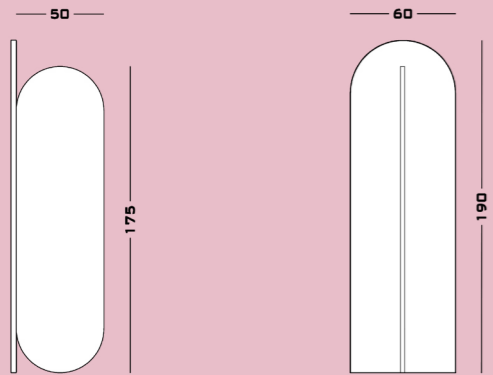

Cod. TAKA

W. 53
D. 60
H. 190

Materials

This catalogue should be used in conjunction with the spec sheet for each product.

Our website offers more images and detailed up-to-date information. Colour samples replicated on this catalogue are indication only and do not replace the use of real samples when ordering, since it is impossible to guarantee a screen reproduction identical to the original.

Copyright © Secolo 2024 All rights reserved

Visit our website secolo.design



Standard Marble Finishes

Standard



Arabescato Orobico 01



Carrara CD 02

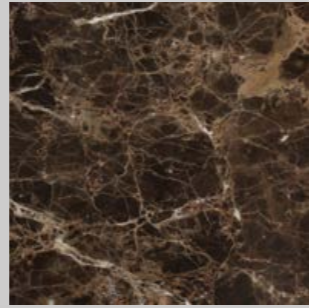

Dark Emperador 03



Nero Marquina 04



Travertino Filled 05



Travertino Open Pore 06

Premium Marble Finishes

Premium



Calacatta 07



Fior Di Pesco 08

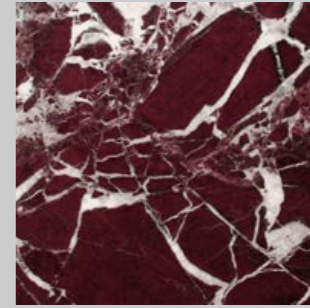

Rosso Levanto 09

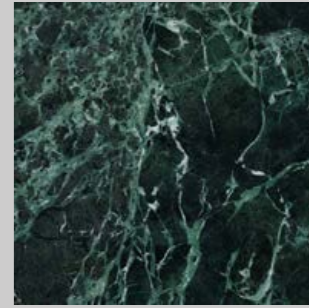

Verde Alpi 10

Metal Satin & Polished Finishes

Satin & Polished



Aluminium 11

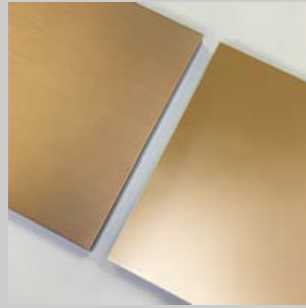

Brass 12

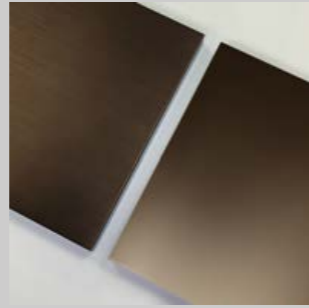

Bronze 13

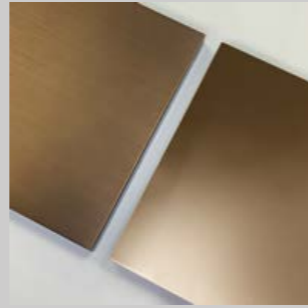

Champagne 14

Metal Lacquered Finishes

Lacquered



Blue Cenere 15



Cenere 16



Jet Black 17



Off White 18

Wood Finishes

Wood



Dark Stained Walnut 19

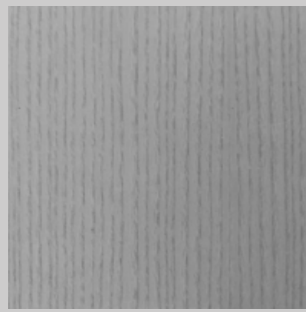

Grey Stained Walnut 20

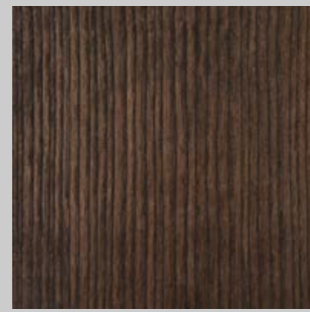

Natural Walnut 21

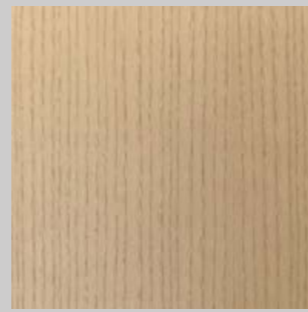

White Oak 22

Wood Lacquered Finishes

Lacquered

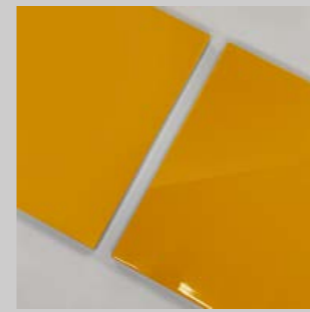

Maize 23

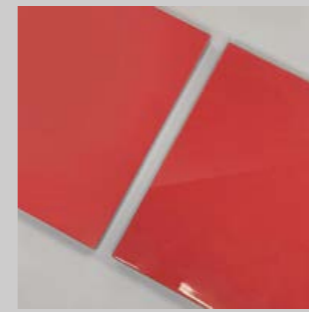

Strawberry Red 24



Red Violet 25

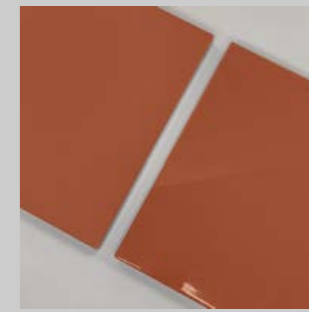

Pearl Orange 26

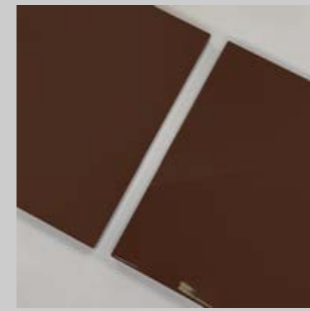

Mahogany Brown 27



Moor Oak 28



Sabbia 29



Tortora 30



Window Grey 31



Tiglio 32



Velvet Green 33



Bottle Green 34

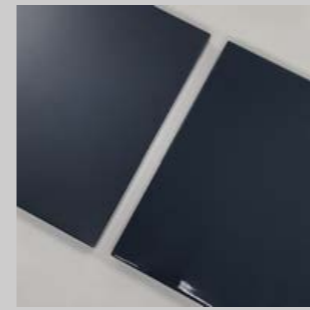

Steel Blue 35

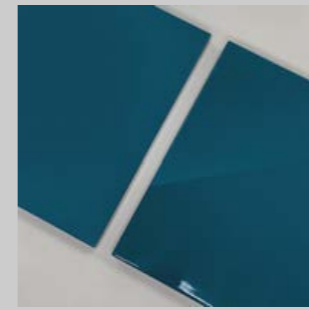

Azure Blue 36



Bird Blue Grey 37



Cenere 38



Blue Cenere 39



Hazy Blue 40



Off White 41



Nude 42

Upholstery Standard Collection

Cocò



Desert Storm 43



Quill Grey 44



Friar Grey 45



River Bed Melange 46

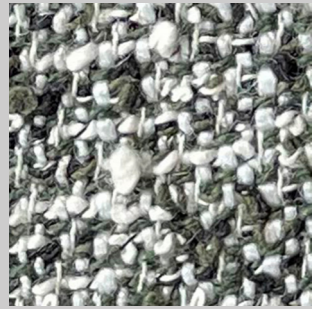

Kelp Melange 47



Mystic Melange 48

Upholstery Standard Collection

Cotton

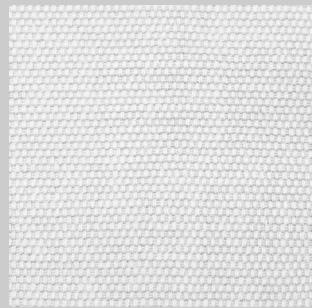

Mercury White 49

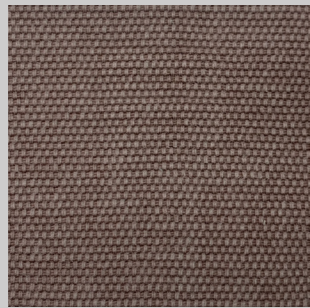

Sand Stone 50

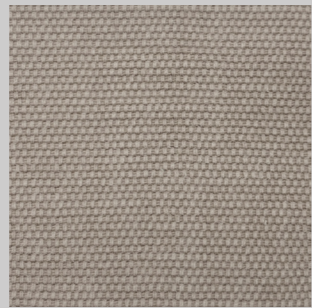

Zorba 51

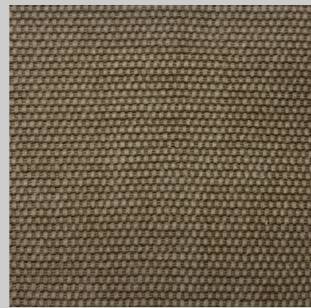

Tobacco Brown 52

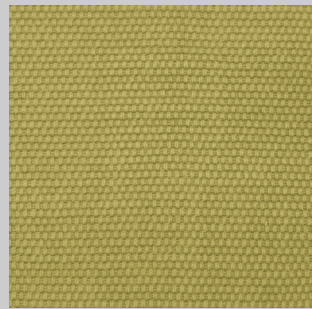

Limed Oak 53

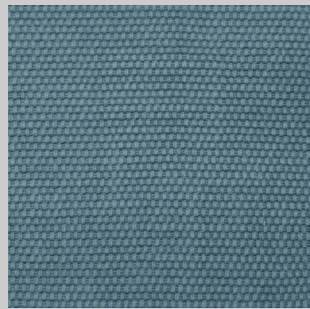

Cutty Shark 54

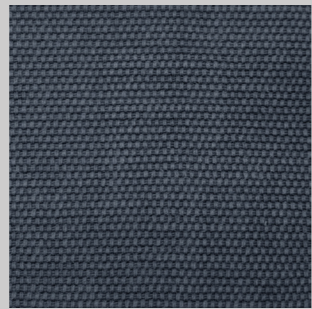

Pale Indigo 55

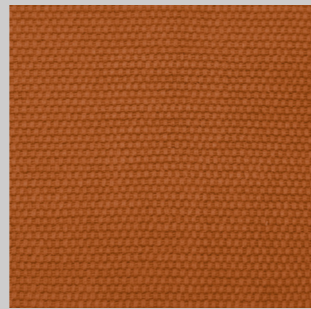

Orange 56

Upholstery Standard Collection

Velvet

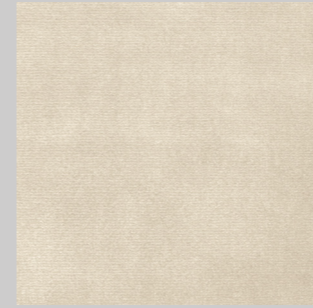

Bone 57

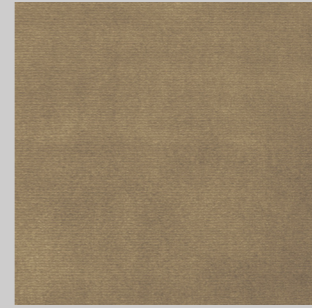

Domino 58



Saddle 59



Walnut 60

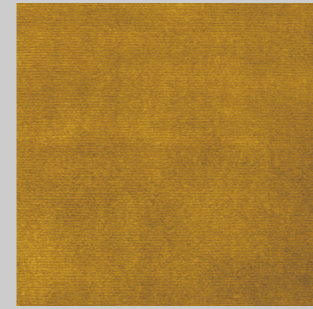

Mustard 61

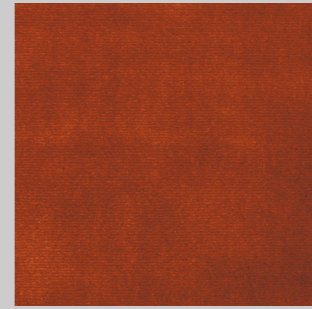

Hazy Blue 62

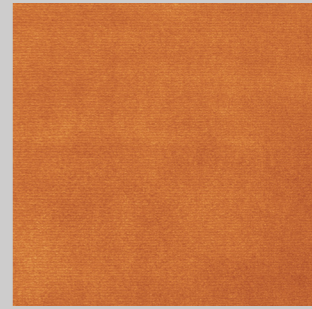

Raw Sienna 63

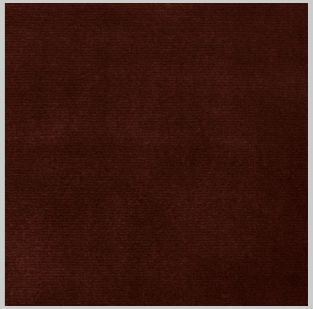

Rebel 64

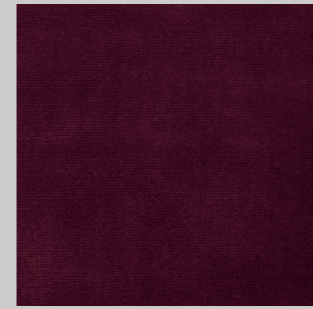

Dark Purple 65

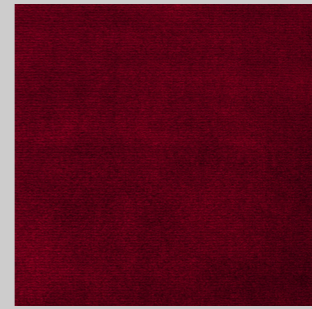

Cardinal Red 66

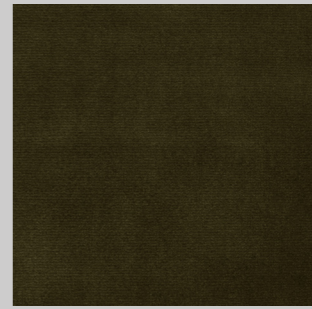

Mikado 67

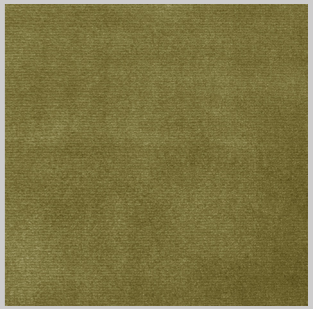

Pesto 68



Eclipse 69

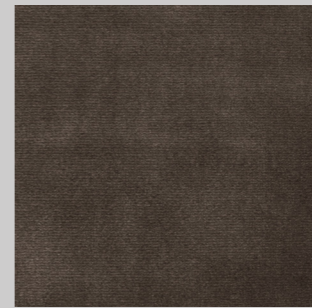

Taupe Brown 70

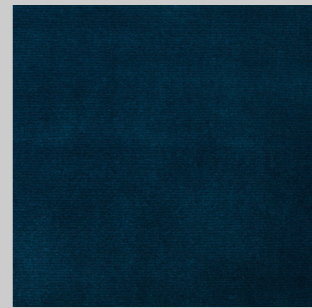

Tiber 71

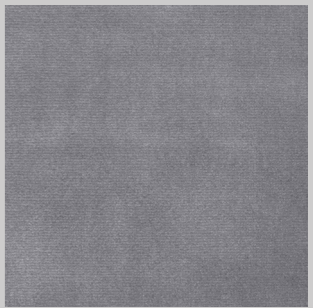

Manatee 72

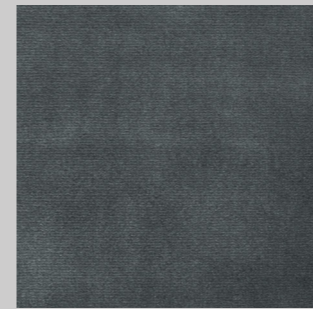

Nevada 73

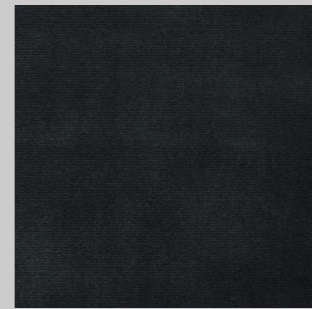

Outer Space 74

Upholstery Premium Collection

Nativo



Alto White 75



Pickled Bean 76



Old Copper 77



Sand 78

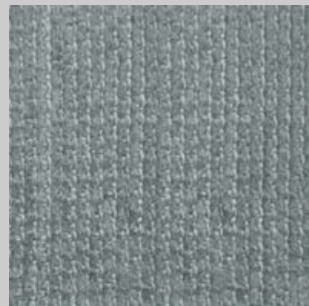

Gunsmoke 79



Blue Mirage 80



Metal Green 81

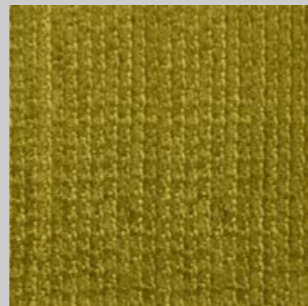

Lime Green 82

Upholstery Premium Collection

Panama



Panama White 83



Panama Clay 84



Panama Green 85

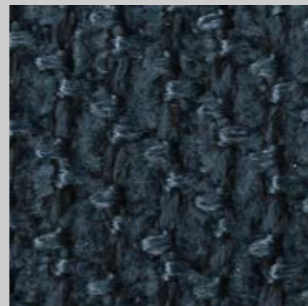

Panama Blue 86

Upholstery Premium Collection

Bouclé Melange

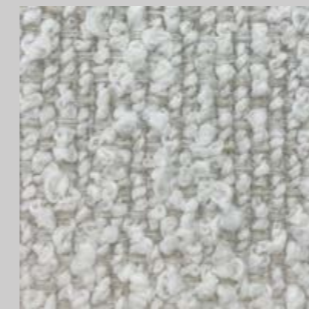

Melange White 87

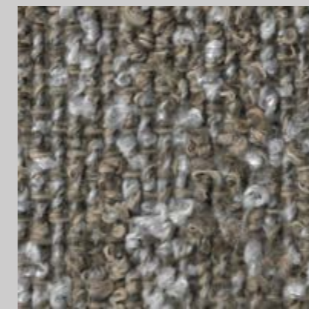

Melange Dove Gray 88

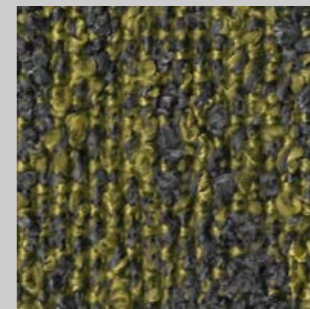

Melange Bright Green 89

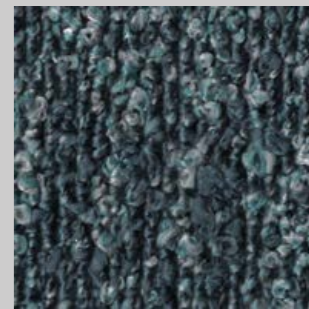

Melange Blue 90

Upholstery Premium Collection

Soft Bouclé

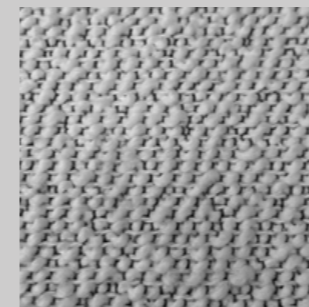

Alabaster 91

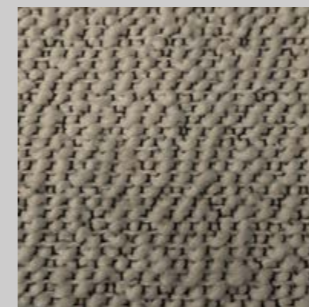

Olive Haze 92

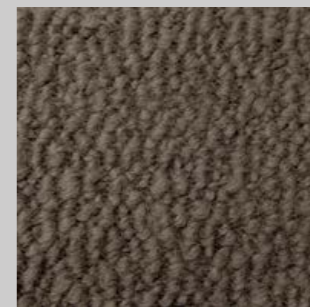

Millbroke 93

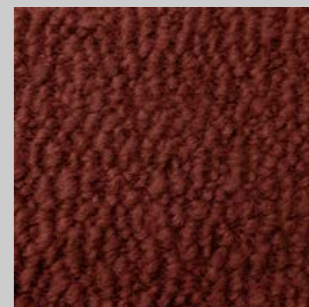

Redwood 94

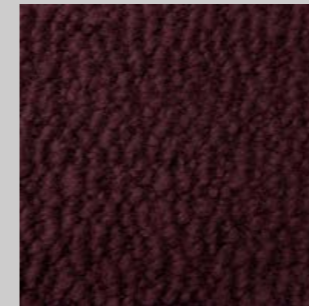

Cedar 95

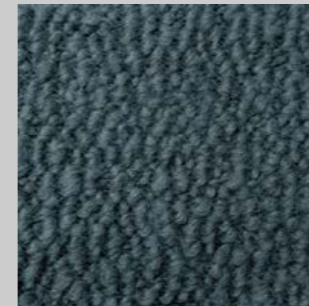

River Bed 96

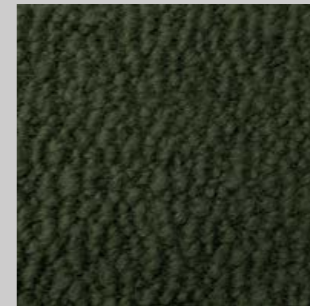

Green Kelp 97

Upholstery Premium Collection

Suede



Lamb 98



Cappuccino 99



Chocolate 100



Cupcake 101



Periwinkle 102

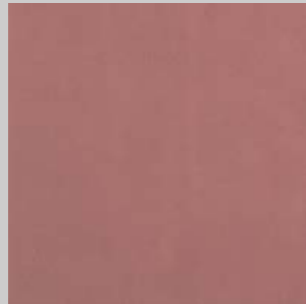

Coquille 103



Masai 104



Bergamot 105



Niagara 106



Plaster 107

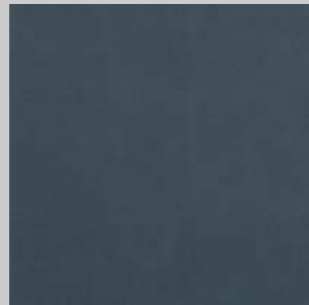

Anchor 108

Upholstery Special Collection

Leather

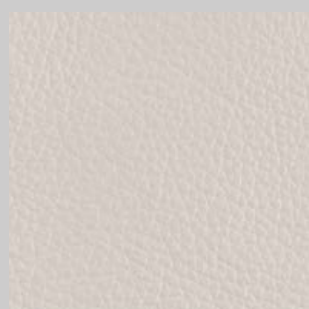

Soul White 109

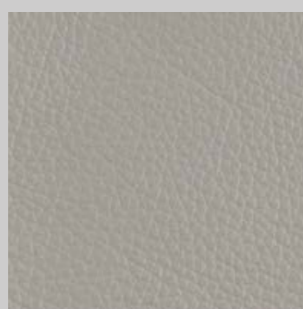

Lamb GR 110



Clay 111

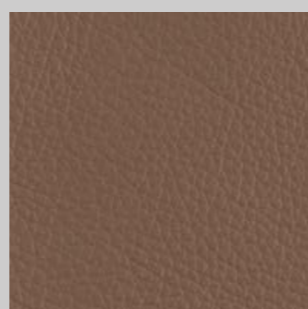

Antilope 112

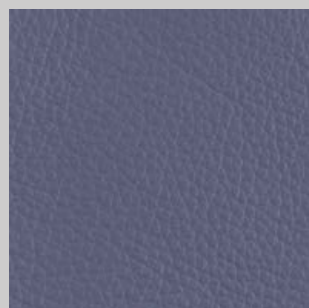

Lavander 113



Berry 114

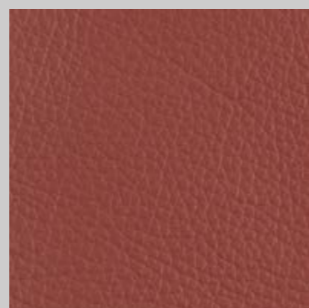

Potpourri 115



Siam 116

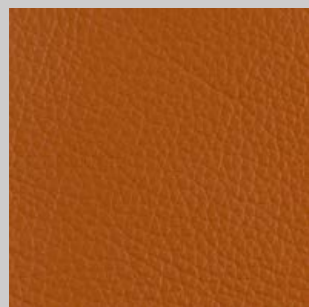

Claw 117

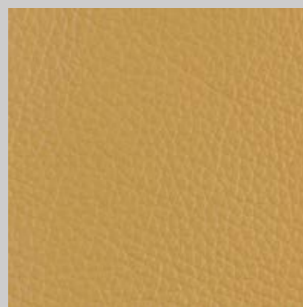

Parchment 118

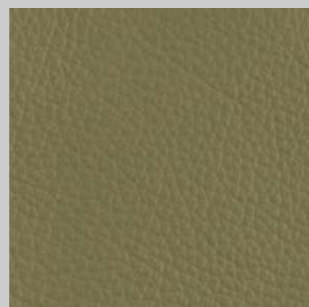

Terragon 119

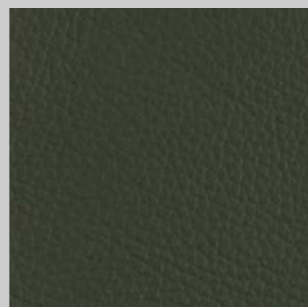

Birch 120

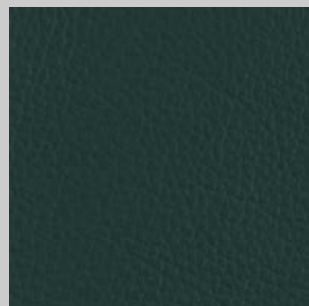

Bottle 121

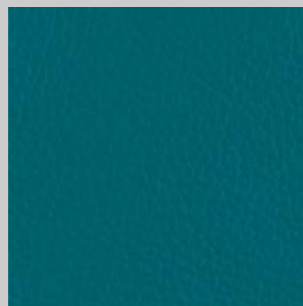

Turquoise 122

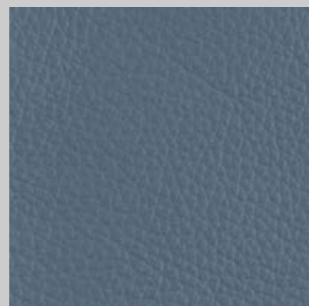

Steel Bird 123

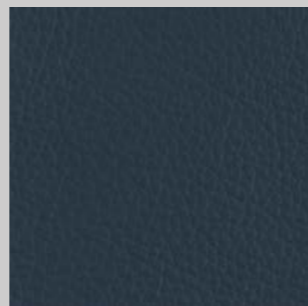

Indigo 124

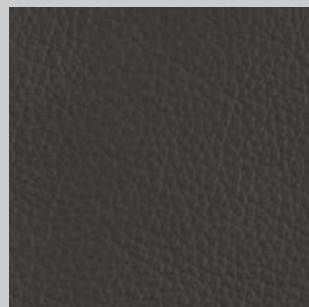

Grayshadow 125

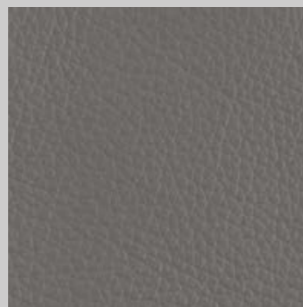

Smoke 126

Upholstery Special Collection

Nabuk

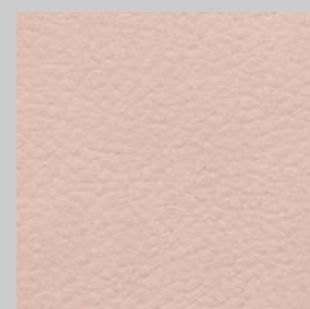

Cipria 127

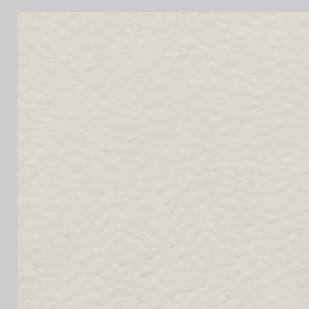

Tide 128

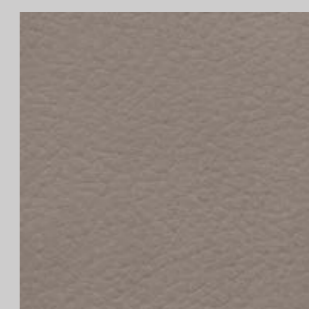

Pine Cone 129

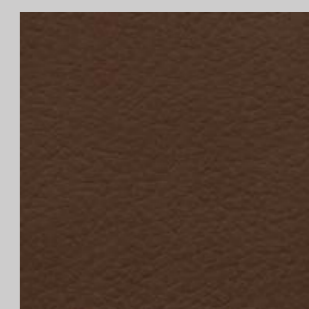

English Walnut 130

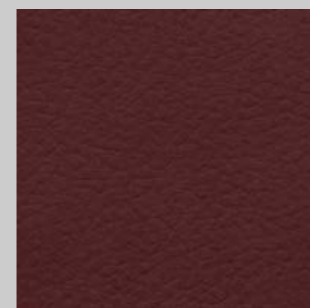

Crater Brown 131

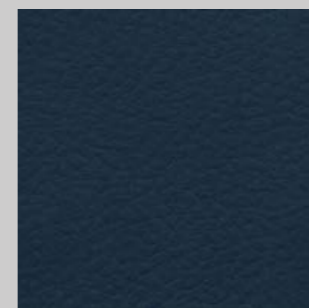

Shark 132

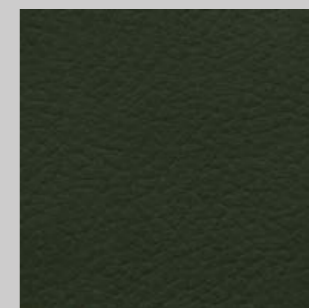

Forest 133



Oslo Gray 134

Upholstery Special Collection

Bouclé



Pearl Bush 135

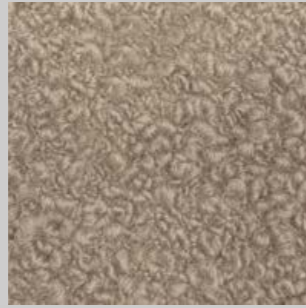

Bison Hide 136

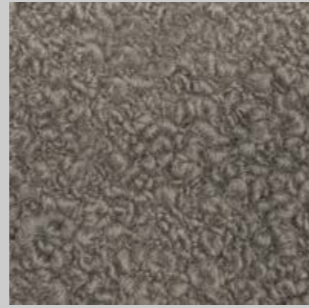

Pale Oyster 137

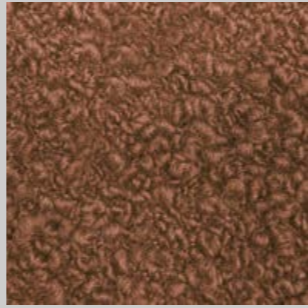

Burnt Orange 138



Falcon 139

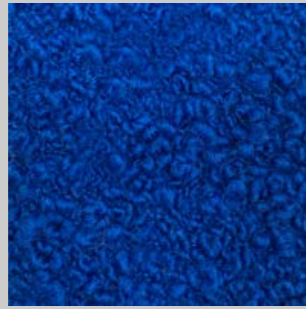

Cobalt 140



Gray Chateau 141



Ebony Clay 142

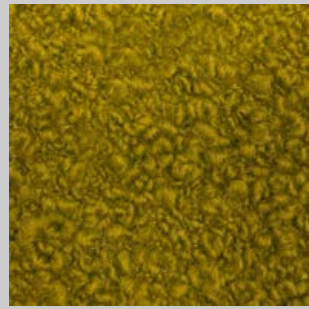

Fuel Yellow 143

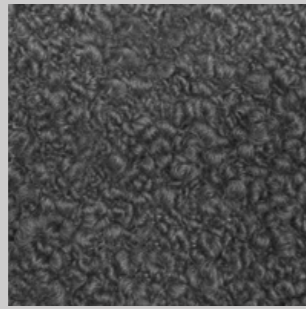

Dove Gray 144



Abbey 145

Production

Quality materials and Italian Manufacturing have always been at the core of our philosophy. Each piece of furniture is meticulously crafted by skilled artisans who have inherited their expertise through generations, ensuring the highest level of quality in every piece.

Not only are our pieces 100% made in Italy, but we also understand the importance of utilising only the finest materials for our products. From the wood selection to the upholstery fabrics and finishes, every choice is carefully made, utilising premium, locally sourced materials.

This attention to detail not only ensures that every piece looks as good as it can, but it also means that Secolo products stand the test of time. Secolo products are built to last and the upmost care is taken to ensure that they do.

Every piece is a testament to the rich heritage of our artisanal craftsmen. We believe that furniture is more than just functional - it's a reflection of style, personality, and artistry. Each piece is made to order, ensuring 100% attention to detail and guaranteeing that your furniture is truly one-of-a-kind.



Contacts

Made In Italy With Love.

Milan

Via Bolzano
28b
20127
Milan

+39 347 6489444

London

305 Harbour Yard
Chelsea Harbour
SW10 OXD
London

Warehouse

Via Walter Tobagi
5b
62029
Tolentino



Website

www.secolo.design

Instagram

[secolo_official](https://www.instagram.com/secolo_official)

Pinterest

[@secolo_official](https://www.pinterest.com/secolo_official)

LinkedIn

[SECOLO_official](https://www.linkedin.com/company/SECOLO_official)

General Enquiries

info@secolo.design

Press & Media Content

digital@secolo.design

Phone

+39 347 6489444

Artistic Direction

Artefatto Design Studio



Website



Instagram



Pinterest